



VASCA BIANCO MORBIDO CON PANNELLI ARGILLA TORTORA



VASCA BIANCO MORBIDO CON PANNELLI BURLINGTON + FRAME BIANCO

DIVINA | FINITURE PANNELLI

ACRILICO



Bianco
lucido

Bianco
morbido

LEGNO



Bianco
rigato

Grain

Burlington

Dolomite

ARGILLA

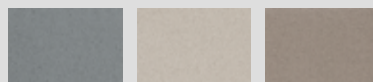

Cenere

Polvere

Tortora

MDI



Umbra

Sabbia

FRAME ALLUMINIO NERO OPACO



Bianco
morbido

LEGNO



Bianco
rigato

Grain

Burlington

Dolomite

ARGILLA

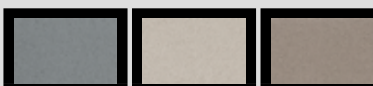

Cenere

Polvere

Tortora

MDI



Umbra

Sabbia

FRAME ALLUMINIO BIANCO OPACO

LEGNO



Bianco
rigato

Grain

Burlington

Dolomite

ARGILLA

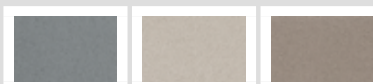

Cenere

Polvere

Tortora

MDI

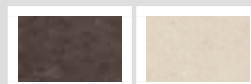

Umbra

Sabbia

DIVINA | FUNZIONI E DOTAZIONI (disponibili a seconda dell'allestimento)



Massaggio Airpool (16 jets) a getto d'aria con accensione manuale on/off. Per una **efficace stimolazione cellulare**.



Massaggio corpo Whirlpool (6 jets) aria/acqua. Per soddisfare qualsiasi esigenza di benessere.



Natural air



Cromolight con 8 variazioni cromatiche per attivare la mente ed emozionare lo spirito.



Accensione soft-touch.



Poggiatesta in materiale antibatterico.



Rubinetteria bordo vasca con cascata e tubo di scarico salvagoccia.



Colonna di scarico con piletta click-clack.



VASCA BIANCO MORBIDO CON PANNELLI BIANCO MORBIDO



Avvolgere il corpo con una soffice nuvola d'ossigeno grazie al sistema Natural Air

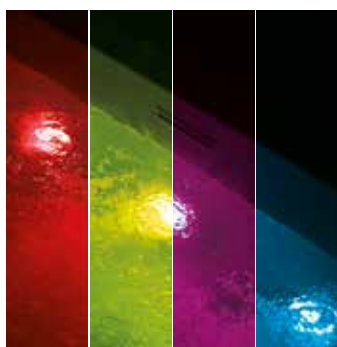

Bocchette Whirlpool con Cromolight integrata per stimolare corpo ed emozioni



Accensione soft-touch con comando capacitivo sul bordo della vasca



**OPTIONAL
SOPRAVASCA DIVINA**
vedi pag. 586, 588

DIVINA

DIVINA



DIVINA

VASCA RETTANGOLARE - BORDO BASSO - 3,5 CM

Design Massimo Farinatti

| Misure | | Capacità | Codice | Scelta rubinetteria + finitura vasca | | | | Scelta struttura/pannelli | |
|--------|---|----------|--------|---------------------------------------|----------------|---------------------------------------------------|----------------|-----------------------------------------------|----------------|
| Cm | H | Lt. | | Colonna di scarico senza rubinetteria | | Colonna di scarico con erogazione da troppo pieno | | Colonna di scarico + rubinetteria bordo vasca | |
| | | | | Bianco lucido | Bianco morbido | Bianco lucido | Bianco morbido | Bianco lucido | Bianco morbido |

| STANDARD DA INCASSO | | | | | | | | | | | |
|---------------------|----|-----|-----------------|----|----|-------|-------|-------|-------|--|--|
| | | | | -A | -U | 1-A0K | 1-U0K | 2-A0K | 2-U0K | | |
| 160 x 70 | 63 | 250 | DI116970 | | | | | | | | |
| 170 x 70 | 63 | 280 | DI117970 | | | | | | | | |
| 170 x 75 | 63 | 300 | DI117975 | | | | | | | | |
| 180 x 80 | 63 | 350 | DI118980 | | | | | | | | |
| 180 x 100 | 63 | 430 | DI118910 | | | | | | | | |
| 190 x 90 | 63 | 420 | DI119990 | | | | | | | | |

| STANDARD CON TELAIO | | | | | | | | | | | |
|---------------------|----|-----|-----------------|----|----|-----|-----|-----|-----|----|-----------------------------------------------------------------------------------------------------------------------------------|
| | | | | -A | -U | 1-A | 1-U | 2-A | 2-U | 0K | * Vedi tabella SCELTA NUMERO PANNELLI +FINITURA PANNELLI |
| 160 x 70 | 63 | 250 | DI216970 | | | | | | | | |
| 170 x 70 | 63 | 280 | DI217970 | | | | | | | | |
| 170 x 75 | 63 | 300 | DI217975 | | | | | | | | |
| 180 x 80 | 63 | 350 | DI218980 | | | | | | | | |
| 180 x 100 | 63 | 430 | DI218910 | | | | | | | | |
| 190 x 90 | 63 | 420 | DI219990 | | | | | | | | |

| HYDRO AIR | | | | | | | | | | | |
|-----------|----|-----|------------------|-----|-----|-----|-----|-----|-----|----|-----------------------------------------------------------------------------------------------------------------------------------|
| | | | | 0-A | 0-U | 1-A | 1-U | 2-A | 2-U | 0K | * Vedi tabella SCELTA NUMERO PANNELLI +FINITURA PANNELLI |
| 160 x 70 | 63 | 250 | DIY169700 | | | | | | | | |
| 170 x 70 | 63 | 280 | DIY179700 | | | | | | | | |
| 170 x 75 | 63 | 300 | DIY179750 | | | | | | | | |
| 180 x 80 | 63 | 350 | DIY189800 | | | | | | | | |
| 180 x 100 | 63 | 430 | DIY189100 | | | | | | | | |
| 190 x 90 | 63 | 420 | DIY199900 | | | | | | | | |

| WHIRLPOOL | | | | | | | | | | | |
|-----------|----|-----|------------------|-----|-----|-----|-----|-----|-----|----|-----------------------------------------------------------------------------------------------------------------------------------|
| | | | | 0-A | 0-U | 1-A | 1-U | 2-A | 2-U | 0K | * Vedi tabella SCELTA NUMERO PANNELLI +FINITURA PANNELLI |
| 160 x 70 | 63 | 250 | DI5169700 | | | | | | | | |
| 170 x 70 | 63 | 280 | DI5179700 | | | | | | | | |
| 170 x 75 | 63 | 300 | DI5179750 | | | | | | | | |
| 180 x 80 | 63 | 350 | DI5189800 | | | | | | | | |
| 180 x 100 | 63 | 430 | DI5189100 | | | | | | | | |
| 190 x 90 | 63 | 420 | DI5199900 | | | | | | | | |

| HYDRO PLUS | | | | | | | | | | | |
|------------|----|-----|------------------|-----|-----|-----|-----|-----|-----|----|-----------------------------------------------------------------------------------------------------------------------------------|
| | | | | 0-A | 0-U | 1-A | 1-U | 2-A | 2-U | 0K | * Vedi tabella SCELTA NUMERO PANNELLI +FINITURA PANNELLI |
| 160 x 70 | 63 | 250 | DI4169700 | | | | | | | | |
| 170 x 70 | 63 | 280 | DI4179700 | | | | | | | | |
| 170 x 75 | 63 | 300 | DI4179750 | | | | | | | | |
| 180 x 80 | 63 | 350 | DI4189800 | | | | | | | | |
| 180 x 100 | 63 | 430 | DI4189100 | | | | | | | | |
| 190 x 90 | 63 | 420 | DI4199900 | | | | | | | | |

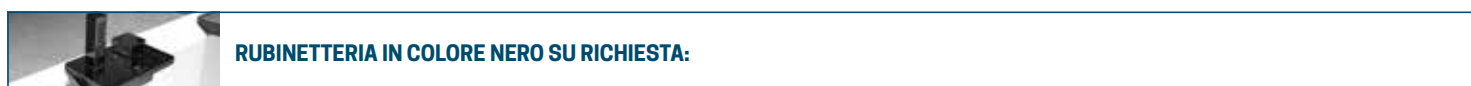

| Misure | | Capacità | Codice | Scelta rubinetteria + finitura vasca | | | Scelta struttura/pannelli | | | | |
|-----------|----------|------------|--------|--------------------------------------|----------------|---------------|---------------------------|---------------|----------------|----------------|--------------|
| Cm | H | Lt. | | | | | | | | | |
| | | | | Bianco lucido | Bianco morbido | Bianco lucido | Bianco morbido | Bianco lucido | Bianco morbido | Solo struttura | Con pannelli |

| NATURAL AIR | | | | | | | | | | | |
|-------------|----|-----|------------------|-----|-----|-----|-----|-----|-----|----|---------------------------------------------------------------------------------------|
| | | | | 0-A | 0-U | 1-A | 1-U | 2-A | 2-U | 0K | * Vedi tabella SCELTA NUMERO PANNELLI +FINITURA PANNELLI |
| 160 x 70 | 63 | 250 | DIN169700 | | | | | | | | |
| 170 x 70 | 63 | 280 | DIN179700 | | | | | | | | |
| 170 x 75 | 63 | 300 | DIN179750 | | | | | | | | |
| 180 x 80 | 63 | 350 | DIN189800 | | | | | | | | |
| 180 x 100 | 63 | 430 | DIN189100 | | | | | | | | |
| 190 x 90 | 63 | 420 | DIN199900 | | | | | | | | |

| NATURAL AIR + WHIRLPOOL | | | | | | | | | | | |
|-------------------------|----|-----|------------------|-----|-----|-----|-----|-----|-----|----|---------------------------------------------------------------------------------------|
| | | | | 0-A | 0-U | 1-A | 1-U | 2-A | 2-U | 0K | * Vedi tabella SCELTA NUMERO PANNELLI +FINITURA PANNELLI |
| 160 x 70 | 63 | 250 | DIP169700 | | | | | | | | |
| 170 x 70 | 63 | 280 | DIP179700 | | | | | | | | |
| 170 x 75 | 63 | 300 | DIP179750 | | | | | | | | |
| 180 x 80 | 63 | 350 | DIP189800 | | | | | | | | |
| 180 x 100 | 63 | 430 | DIP189100 | | | | | | | | |
| 190 x 90 | 63 | 420 | DIP199900 | | | | | | | | |

| Scelta numero pannelli | | | | Scelta finitura pannelli /prezzo | | | | | | |
|------------------------|-------------------------|-------------------------|-------------------------|----------------------------------|--------------|---------------|----------|------------|----------|--|
| | | | | LAMINATO | | LEGNI | | | | |
| 1 frontale | 1 frontale + 1 laterale | 1 frontale + 2 laterali | 2 frontali + 2 laterali | Bianco Lucido | Bianco Opaco | Bianco rigato | Grain | Burlington | Dolomite | |
| 1 | 2 | 3 | 4 | A | U | I | M | N | X | |
| | - | - | - | | | | | | | |
| - | | - | - | | | | | | | |
| - | - | | - | | | | | | | |
| - | - | - | | | | | | | | |

SCEGLI ALTRE FINITURE NELLA PAGINA SEGUENTE

Costruzione codice vasca senza pannelli **Codice** + **Scelta scarico/erogazione + Finitura vasca** + **Scelta struttura senza pannelli** = Codice prodotto finale

Costruzione codice vasca con pannelli **Codice** + **Scelta scarico/erogazione + Finitura vasca** + **Scelta struttura con pannelli (acrilico o legni)** = Codice prodotto finale

COLORI SPECIALI SU RICHIESTA PER PANNELLI ARGILLA



| PANNELLI | Prezzo |
|--------------|--------|
| 1-2 pannelli | |
| 3-4 pannelli | |

DIVINA

PER LA VERSIONE CON I PANNELLI IN FINITURA ARGILLA/FRAME ORDINARE: 1 CODICE VASCA SOLO STRUTTURA + 1 CODICE PANNELLI ARGILLA/FRAME (QUI SOTTO)

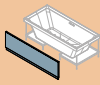
| Misure | CODICE Scelta numero pannelli | Scelta finitura pannelli | | | | |
|------------------------|-----------------------------------------------------------------------------------|--------------------------|----------|----------|----------|----------|
| | | ARGILLA | | | MDI | |
| |  | Cenere | Polvere | Tortora | Umbr | Sabbia |
| | 1 frontale | | | | | |
| | 1 | R | O | S | 1 | 2 |
| 160 x 70 | PANV1FDI169- | | | | | |
| 170 x 70; 170 x 75 | PANV1FDI179- | | | | | |
| 180 x 80; 180 x 100 | PANV1FDI189- | | | | | |
| 190 x 90 | PANV1FDI199- | | | | | |

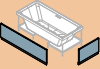
| Misure | CODICE Scelta numero pannelli | Scelta finitura pannelli | | | | |
|-----------|-----------------------------------------------------------------------------------|--------------------------|----------|----------|----------|----------|
| | | ARGILLA | | | MDI | |
| |  | Cenere | Polvere | Tortora | Umbr | Sabbia |
| | 1 frontale + 1 laterale | | | | | |
| | 2 | R | O | S | 1 | 2 |
| 160 x 70 | PANV1F1LDI16970- | | | | | |
| 170 x 70 | PANV1F1LDI17970- | | | | | |
| 170 x 75 | PANV1F1LDI17975- | | | | | |
| 180 x 80 | PANV1F1LDI18980- | | | | | |
| 180 x 100 | PANV1F1LDI18910- | | | | | |
| 190 x 90 | PANV1F1LDI19990- | | | | | |

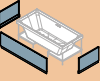
| Misure | CODICE Scelta numero pannelli | Scelta finitura pannelli | | | | |
|-----------|-------------------------------------------------------------------------------------|--------------------------|----------|----------|----------|----------|
| | | ARGILLA | | | MDI | |
| |  | Cenere | Polvere | Tortora | Umbr | Sabbia |
| | 1 frontale + 2 laterali | | | | | |
| | 3 | R | O | S | 1 | 2 |
| 160 x 70 | PANV1F2LDI16970- | | | | | |
| 170 x 70 | PANV1F2LDI17970- | | | | | |
| 170 x 75 | PANV1F2LDI17975- | | | | | |
| 180 x 80 | PANV1F2LDI18980- | | | | | |
| 180 x 100 | PANV1F2LDI18910- | | | | | |
| 190 x 90 | PANV1F2LDI19990- | | | | | |

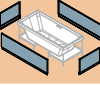
| Misure | CODICE Scelta numero pannelli | Scelta finitura pannelli | | | | |
|-----------|-------------------------------------------------------------------------------------|--------------------------|----------|----------|----------|----------|
| | | ARGILLA | | | MDI | |
| |  | Cenere | Polvere | Tortora | Umbr | Sabbia |
| | 2 frontali + 2 laterali | | | | | |
| | 4 | R | O | S | 1 | 2 |
| 160 x 70 | PANV2F2LDI16970- | | | | | |
| 170 x 70 | PANV2F2LDI17970- | | | | | |
| 170 x 75 | PANV2F2LDI17975- | | | | | |
| 180 x 80 | PANV2F2LDI18980- | | | | | |
| 180 x 100 | PANV2F2LDI18910- | | | | | |
| 190 x 90 | PANV2F2LDI19990- | | | | | |

| Finitura FRAME | Scelta finitura pannelli per FRAME | | | | | | | | | |
|-------------------|------------------------------------|------------|-------|------------|----------|---------|---------|---------|------|--------|
| | FRAME | | LEGNI | | | ARGILLA | | | MDI | |
| | Bianco Opaco | Nero Opaco | Grain | Burlington | Dolomite | Cenere | Polvere | Tortora | Umbr | Sabbia |
| U | | | | | | | | | | |
| H | | | | | | | | | | |
| U | | | | | | | | | | |
| M | | | | | | | | | | |
| N | | | | | | | | | | |
| X | | | | | | | | | | |
| R | | | | | | | | | | |
| O | | | | | | | | | | |
| S | | | | | | | | | | |
| 1 | | | | | | | | | | |
| 2 | | | | | | | | | | |

| Finitura FRAME | Scelta finitura pannelli per FRAME | | | | | | | | | |
|-------------------|------------------------------------|------------|-------|------------|----------|---------|---------|---------|------|--------|
| | FRAME | | LEGNI | | | ARGILLA | | | MDI | |
| | Bianco Opaco | Nero Opaco | Grain | Burlington | Dolomite | Cenere | Polvere | Tortora | Umbr | Sabbia |
| U | | | | | | | | | | |
| H | | | | | | | | | | |
| U | | | | | | | | | | |
| M | | | | | | | | | | |
| N | | | | | | | | | | |
| X | | | | | | | | | | |
| R | | | | | | | | | | |
| O | | | | | | | | | | |
| S | | | | | | | | | | |
| 1 | | | | | | | | | | |
| 2 | | | | | | | | | | |

| Finitura FRAME | Scelta finitura pannelli per FRAME | | | | | | | | | |
|-------------------|------------------------------------|------------|-------|------------|----------|---------|---------|---------|------|--------|
| | FRAME | | LEGNI | | | ARGILLA | | | MDI | |
| | Bianco Opaco | Nero Opaco | Grain | Burlington | Dolomite | Cenere | Polvere | Tortora | Umbr | Sabbia |
| U | | | | | | | | | | |
| H | | | | | | | | | | |
| U | | | | | | | | | | |
| M | | | | | | | | | | |
| N | | | | | | | | | | |
| X | | | | | | | | | | |
| R | | | | | | | | | | |
| O | | | | | | | | | | |
| S | | | | | | | | | | |
| 1 | | | | | | | | | | |
| 2 | | | | | | | | | | |

| Finitura FRAME | Scelta finitura pannelli per FRAME | | | | | | | | | |
|-------------------|------------------------------------|------------|-------|------------|----------|---------|---------|---------|------|--------|
| | FRAME | | LEGNI | | | ARGILLA | | | MDI | |
| | Bianco Opaco | Nero Opaco | Grain | Burlington | Dolomite | Cenere | Polvere | Tortora | Umbr | Sabbia |
| U | | | | | | | | | | |
| H | | | | | | | | | | |
| U | | | | | | | | | | |
| M | | | | | | | | | | |
| N | | | | | | | | | | |
| X | | | | | | | | | | |
| R | | | | | | | | | | |
| O | | | | | | | | | | |
| S | | | | | | | | | | |
| 1 | | | | | | | | | | |
| 2 | | | | | | | | | | |

FRAME SOLO SU PANNELLI FRONTALI

* LA FINITURA DI PANNELLO BIANCO OPACO È DISPONIBILE SOLO CON FRAME NERO OPACO

Costruzione del codice **Codice** + **Finitura pannelli** = Codice prodotto finale

Costruzione del codice **Codice** + **Finitura Frame** + **Finitura pannelli** = Codice prodotto finale

OPTIONAL PER VASCHE

POGGIATESTA IN EVA*

per Divina e Divina O

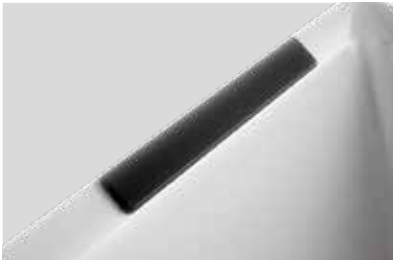

Codice

Prezzo

POGDIV

POGGIATESTA IN EVA *

per Divina C



Codice

Prezzo

POGDIVC

POGGIATESTA IN EVA*

per Iris versione in nicchia



Codice

Prezzo

POGIRIN

POGGIATESTA IN EVA*

per Calos 2.0



Codice

Prezzo

POGCA1

POGGIATESTA IN EVA *

per Calypso



Codice

Prezzo

POGCAL

POGGIATESTA IN EVA*

per Vogue



Codice

Prezzo

POGVOG

MENSOLINA PORTAOGGETTI BORDO VASCA

per Divina, Divina C, O e F



Codice

Prezzo

R90PODIV

PIANO PORTAOGGETTI SOPRA VASCA

per Divina e Divina F



Larghezza

Codice

Prezzo

70 cm

R90VADIV70

75 cm

R90VADIV75

80 cm

R90VADIV80

90 cm

R90VADIV90

PROFILO DI FINITURA RIGIDO IN ALLUMINO



Misure

Codice

Prezzo

1 lato 185 cm

PRV185-30

2 lati 185x85 cm

PRV18585-30

3 lati 85x185x85 cm

PRV8518585-30

*EVA è un materiale atossico, antibatterico e idrorepellente

OPTIONAL PER VASCHE

PROFILO DI FINITURA I. 400 cm



| Codice | Prezzo |
|--------|--------|
|--------|--------|

PRVA2-A

PROFILO DI FINITURA IN PLASTICA



| Codice | Prezzo |
|--------|--------|
|--------|--------|

PRVA195-30

TUBO DI SCARICO SALVAGOCCIA



STILE, IRIS, CALOS 2.0, UNA, VOGUE, VENUS, CALYPSO

| Codice | Prezzo |
|--------|--------|
|--------|--------|

R90SCDOCBV

SENSE, DIVINA

| Codice | Prezzo |
|--------|--------|
|--------|--------|

R90SGCVSEDI

COLONNA DI SCARICO

per vasche senza erogatore



SENSE

| Codice | Prezzo |
|--------|--------|
|--------|--------|

COLSCAVK-K

CALYPSO, VOGUE, VENUS, CALOS 2.0

| Codice | Prezzo |
|--------|--------|
|--------|--------|

COLSCA-K

COLONNA DI SCARICO CON EROGATORE

per vasche con erogatore



| Codice | Prezzo |
|--------|--------|
|--------|--------|

COLSCAE-K

PANNELLO D'ISPEZIONE PER VASCA AD INCASSO 60x33x2 cm



SENSE

| Codice | Prezzo |
|--------|--------|
|--------|--------|

PANISPEL-A

IRIS, CALOS 2.0, UNA, VOGUE, VENUS, CALYPSO, BABY

| Codice | Prezzo |
|--------|--------|
|--------|--------|

PANISP-A

KIT PIEDINI REGOLABILI PER VASCHE AD INCASSO

per Sense, Iris, Calos 2.0



| Codice | Prezzo |
|--------|--------|
|--------|--------|

PIEDVASCA

KIT PIEDINI REGOLABILI

per Divina, Calos 2.0, Una, Vogue, Venus, Calypso



| Codice | Prezzo |
|--------|--------|
|--------|--------|

PIEDVASCA70

PIEDVASCA75

PIEDVASCA80

PIEDVASCA90

PIEDVASCA100

KIT SOPRAVASCA DIVINA



Per il sopravasca Divina ordinare:

1 sopravasca Young 2.0 1V/1BSV + 1 kit raccordo vasca

vedi pag. 586, 588

KIT **HYDROSILENCE**



DIVINA DUAL

| Misure | Struttura | Codice | Prezzo |
|-----------|------------|------------------------|--------|
| 190 x 140 | 1 Pannello | KUSDIV1F19014 | |
| 190 x 140 | 2 Pannelli | KUSDIV1FL19014 | |
| 190 x 140 | 3 Pannelli | KUSDIV1F2L19014 | |
| 190 x 140 | 4 Pannelli | KUSDIV2F2L19014 | |

DIVINA C

| Misure | Struttura | Codice | Prezzo |
|-----------|------------|----------------|--------|
| 140 x 140 | 1 Pannello | KUSDIVC | |

DIVINA O

| Misure | Struttura | Codice | Prezzo |
|----------|------------|----------------|--------|
| 165 X 98 | 1 Pannello | KUSDIVO | |

DIVINA 160/170 - SENSE 3-4

| Misure | Struttura | Codice | Prezzo |
|---------|------------|----------------------|--------|
| 160/170 | 4 Pannelli | KUSDIV2F2L160 | |

DIVINA 180/190 - SENSE 3-4

| Misure | Struttura | Codice | Prezzo |
|---------|------------|----------------------|--------|
| 180/190 | 4 Pannelli | KUSDIV2F2L190 | |

DIVINA - SENSE 3-4

| Struttura | Codice | Prezzo |
|------------|-------------------|--------|
| 3 Pannelli | KUSDIV1F2L | |

DIVINA - SENSE 3-4 ANGOLO

| Struttura | Codice | Prezzo |
|------------|-------------------|--------|
| 2 Pannelli | KUSDIV1F1L | |

DIVINA - SENSE 3-4 NICCHIA

| Struttura | Codice | Prezzo |
|------------|-----------------|--------|
| 1 Pannello | KUSDIV1F | |

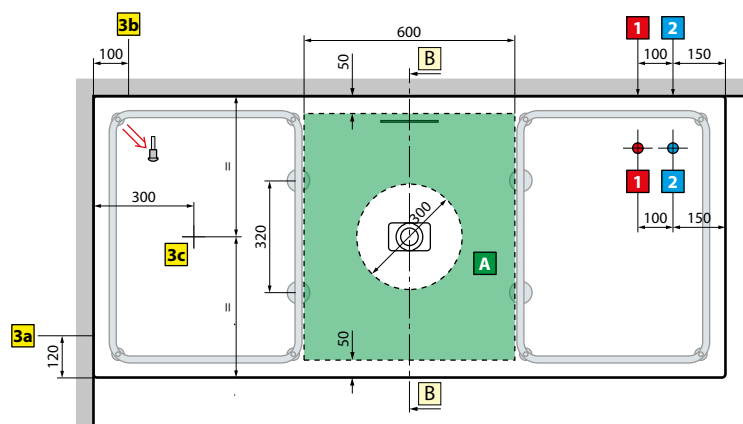
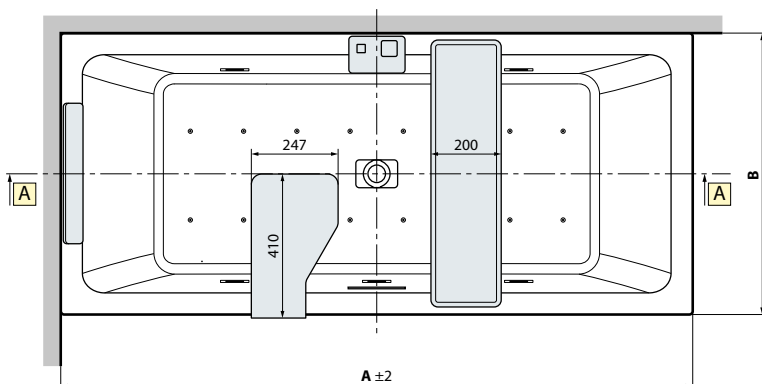
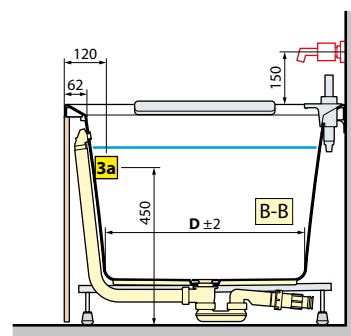
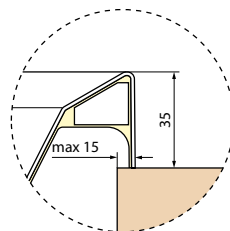
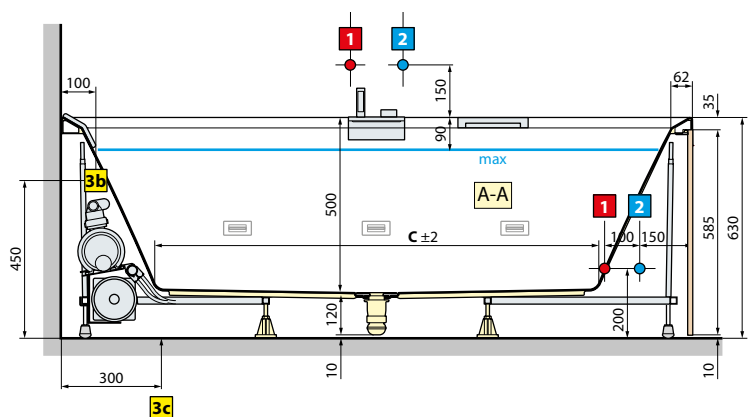

| modello | A | B | C | D | Capacità litri |
|----------------|------|------|------|-----|----------------|
| 160x70 | 1600 | 700 | 1050 | 460 | 250 |
| 170x70 | 1700 | 700 | 1150 | 460 | 280 |
| 170x75 | 1700 | 750 | 1150 | 510 | 300 |
| 180x80 | 1800 | 800 | 1250 | 560 | 350 |
| 180x100 | 1800 | 1000 | 1250 | 760 | 430 |
| 190x90 | 1900 | 900 | 1350 | 660 | 420 |

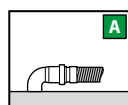

CARATTERISTICHE IDRAULICHE

16 bocchette airpool
6 bocchette whirlpool
Allaccio sifone con raccordo 1 1/2"

CARATTERISTICHE ELETTRICHE

Tensione 220-230 V
Frequenza 50 Hz
Potenza massima assorbita:
Whirlpool: 900 W
Airpool: 400 W
Plus: 1300 W
Natural Air: 1050 W

Installare a monte dell'apparecchio un interruttore differenziale da 30mA provvisto di interruttore onnipolare con apertura minima dei contatti ≥ 3 mm.

