



VOGUE

VASCA ANGOLARE ASIMMETRICA SEMICIRCOLARE

Misure	Capacità	Codice	Scelta rubinetteria + finitura vasca	Installazione	Scelta pannelli
Cm	H	lt.	Colonna di scarico senza rubinetteria Colonna di scarico con erogazione da troppo pieno Colonna di scarico + rubinetteria bordo vasca	Sinistra Destra	Con telaio 1 Pannello

STANDARD DA INCASSO									
			C	E	F	S-A	D-A		
150 X 85	55	140	VOG115085	-	-	-			
165 X 85	55	180	VOG116585	-	-	-			

STANDARD CON TELAIO									
			C	E	F	S-	D-	A0	A1
150 X 85	55	140	VOG215085						
165 X 85	55	180	VOG216585						

HYDRO CON TELAIO SENZA DISINFEZIONE									
			C	E	F	S-	D-	A0K	A1K
150 X 85	55	140	VOG515085O						
165 X 85	55	180	VOG516585O						

HYDRO CON TELAIO E DISINFEZIONE									
			C	E	F	S-	D-	A0K	A1K
150 X 85	55	140	VOG315085P						
165 X 85	55	180	VOG316585P						

HYDRO PLUS CON TELAIO									
			C	E	F	S-	D-	A0K	A1K
150 X 85	55	140	VOG415085P						
165 X 85	55	180	VOG416585P						

ECO CON TELAIO SENZA DISINFEZIONE									
						S-	D-		A1K
150 X 85	55	140	VOG615085MC	-	-	-			
165 X 85	55	180	VOG616585MC	-	-	-			

PER TUTTI GLI OPTIONAL VEDI PAG. 549, 550



FINITURA
VASCA



Bianco
lucido



FUNZIONI E DOTAZIONI

(disponibili a seconda dell'allestimento)



Massaggio Airpool (12 jets) a getto d'aria con accensione manuale on/off. Per una **efficace stimolazione cellulare**



Massaggio corpo Whirlpool (6 jets) aria/acqua con regolazione di tempo e intensità manuale o automatica. Per soddisfare qualsiasi esigenza di benessere.



Pannello di controllo con funzioni Hydro sequence



Poggiatesta in materiale antibatterico



Colonna di scarico



Disinfezione

VOGUE



OPTIONAL PER VASCHE

POGGIATESTA IN EVA*
per Divina e Divina O



Codice	Prezzo
POGDIV	

POGGIATESTA IN EVA *
per Divina C



Codice	Prezzo
POGDIVC	

POGGIATESTA IN EVA*
per Iris versione in nicchia



Codice	Prezzo
POGIRIN	

POGGIATESTA IN EVA*
per Calos 2.0



Codice	Prezzo
POGCA1	

POGGIATESTA IN EVA *
per Calypso



Codice	Prezzo
POGCAL	

POGGIATESTA IN EVA*
per Vogue



Codice	Prezzo
POGVOG	

**MENSOLINA PORTAOGGETTI
BORDO VASCA**
per Divina, Divina C, O e F



Codice	Prezzo
R90PODIV	

PIANO PORTAOGGETTI SOPRA VASCA
per Divina e Divina F



Larghezza	Codice	Prezzo
70 cm	R90VADIV70	
75 cm	R90VADIV75	
80 cm	R90VADIV80	
90 cm	R90VADIV90	

**PROFILO DI FINITURA RIGIDO
IN ALLUMINIO**



Misure	Codice	Prezzo
1 lato 185 cm	PRV185-30	
2 lati 185x85 cm	PRV18585-30	
3 lati 85x185x85 cm	PRV8518585-30	

*EVA è un materiale atossico, antibatterico e idrorepellente

OPTIONAL PER VASCHE

PROFILO DI FINITURA I. 400 cm



Codice	Prezzo
--------	--------

PRVA2-A

PROFILO DI FINITURA IN PLASTICA



Codice	Prezzo
--------	--------

PRVA195-30

TUBO DI SCARICO SALVAGOCCIA



Codice	Prezzo
--------	--------

R90SCDOCBV

IRIS, CALOS 2.0, UNA, VOGUE, VENUS, CALYPSO

COLONNA DI SCARICO per vasche senza erogatore



Codice	Prezzo
--------	--------

COLSCAVK-K

COLONNA DI SCARICO CON EROGATORE per vasche con erogatore



Codice	Prezzo
--------	--------

COLSCAE-K

PANNELLO D'ISPEZIONE PER VASCA AD INCASSO 60x33x2 cm



SENSE

Codice	Prezzo
--------	--------

PANISPEL-A

IRIS, CALOS 2.0, UNA, VOGUE, VENUS, CALYPSO, BABY

Codice	Prezzo
--------	--------

PANISP-A

KIT PIEDINI REGOLABILI PER VASCHE AD INCASSO per Sense, Iris, Calos 2.0



Codice	Prezzo
--------	--------

PIEDVASCA

KIT PIEDINI REGOLABILI per Divina, Calos 2.0, Una, Vogue, Venus, Calypso



Codice	Prezzo
--------	--------

PIEDVASCA70

PIEDVASCA75

PIEDVASCA80

PIEDVASCA90

PIEDVASCA100

KIT SOPRAVASCA DIVINA



Per il sopravasca Divina ordinare:

**1 sopravasca Young 2.0 1V/1BSV +
1 kit raccordo vasca**

vedi pag. 580, 582

VERSIONE SINISTRA

VERSIONE DESTRA

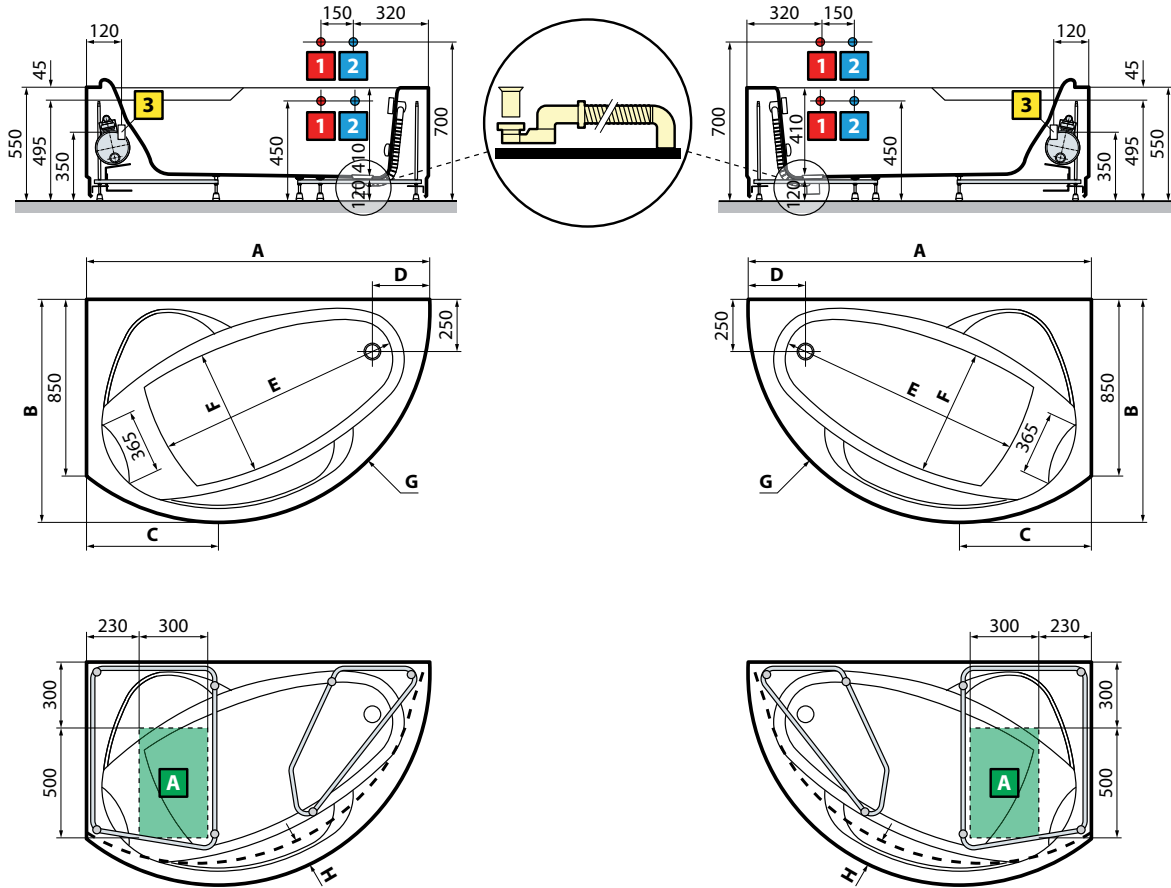

modello	A	B	C	D	E	F	G	H	Capacità litri
150x85	1500	1015	550	290	1030	580	962	137	140
165x85	1650	1070	630	280	1150	640	1015	155	180

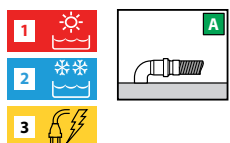

ATTENZIONE!
Può essere dannoso ai portatori di pacemakers

Installare a monte dell'apparecchio un interruttore differenziale da 30mA provvisto di interruttore onnipolare con apertura minima dei contatti ≥ 3 mm.

CARATTERISTICHE IDRAULICHE

5/7 bocchette whirlpool
12 bocchette airpool
Allaccio sifone con raccordo 1 1/2"

CARATTERISTICHE ELETTRICHE

Tensione 220-230 V
Frequenza 50 Hz
Potenza massima assorbita: 950 W
Whirlpool: 550 W
Airpool: 400 W