















# UNA

## VASCA ANGOLARE SIMMETRICA SEMICIRCOLARE

Misure			Capacità	Codice	Scelta rubinetteria + finitura vasca			Scelta struttura / prezzo	
Cm	H	It.			Colonna di scarico senza rubinetteria	Colonna di scarico con erogazione da troppo pieno	Colonna di scarico + rubinetteria bordo vasca	Con telaio	1 Pannello
									
<b>STANDARD DA INCASSO</b>									
135 x 135	55	190	<b>UNA1135135</b>	-	-	-	-	<b>-A</b>	-
<b>STANDARD CON TELAIO</b>									
135 x 135	55	190	<b>UNA2135135</b>	<b>C-</b>	<b>E-</b>	<b>F-</b>	<b>A0</b>	<b>A1</b>	
<b>HYDRO CON TELAIO SENZA DISINFEZIONE</b>									
135 x 135	55	190	<b>UNA51351350</b>	<b>C-</b>	<b>E-</b>	<b>F-</b>	<b>A0K</b>	<b>A1K</b>	
<b>HYDRO CON TELAIO E DISINFEZIONE</b>									
135 x 135	55	190	<b>UNA3135135P</b>	<b>C-</b>	<b>E-</b>	<b>F-</b>	<b>A0K</b>	<b>A1K</b>	   
<b>HYDRO PLUS CON TELAIO</b>									
135 x 135	55	190	<b>UNA4135135P</b>	<b>C-</b>	<b>E-</b>	<b>F-</b>	<b>A0K</b>	<b>A1K</b>	    

PER TUTTI GLI OPTIONAL VEDI PAG. 549, 550



FINITURA  
VASCA



Bianco  
lucido

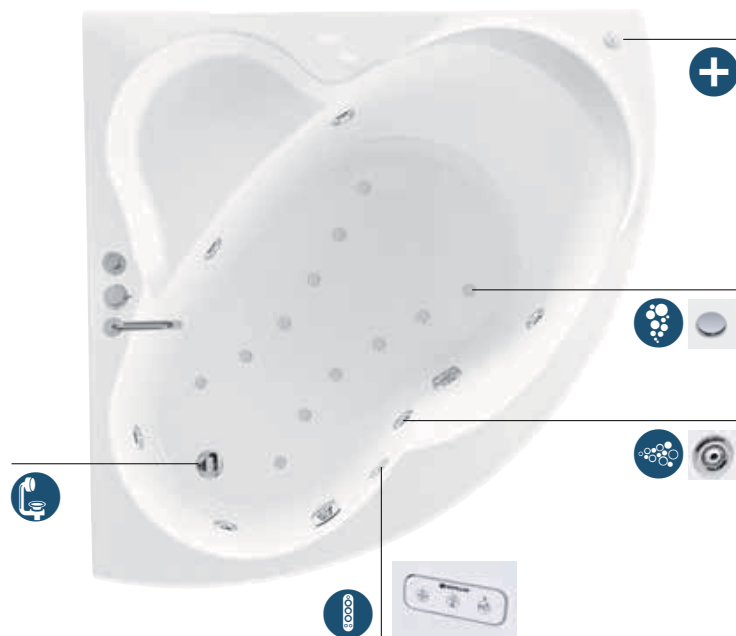

## FUNZIONI E DOTAZIONI

(disponibili a seconda dell'allestimento)



**Massaggio Airpool (12 jets)** a getto d'aria con accensione manuale on/off. Per una **efficace stimolazione cellulare**



**Massaggio corpo Whirlpool (6 jets)** aria/acqua con regolazione di tempo e intensità manuale o automatica. Per soddisfare qualsiasi esigenza di benessere.



**Pannello di controllo** con funzioni Hydro sequence



**Colonna di scarico**



**Disinfezione**



# UNA

## OPTIONAL PER VASCHE

**POGGIATESTA IN EVA\***  
per Divina e Divina O



Codice	Prezzo
<b>POGDIV</b>	

**POGGIATESTA IN EVA \***  
per Divina C



Codice	Prezzo
<b>POGDIVC</b>	

**POGGIATESTA IN EVA\***  
per Iris versione in nicchia



Codice	Prezzo
<b>POGIRIN</b>	

**POGGIATESTA IN EVA\***  
per Calos 2.0



Codice	Prezzo
<b>POGCA1</b>	

**POGGIATESTA IN EVA \***  
per Calypso



Codice	Prezzo
<b>POGCAL</b>	

**POGGIATESTA IN EVA\***  
per Vogue



Codice	Prezzo
<b>POGVOG</b>	

**MENSOLINA PORTAOGGETTI  
BORDO VASCA**  
per Divina, Divina C, O e F



Codice	Prezzo
<b>R90PODIV</b>	

**PIANO PORTAOGGETTI SOPRA VASCA**  
per Divina e Divina F



Larghezza	Codice	Prezzo
70 cm	<b>R90VADIV70</b>	
75 cm	<b>R90VADIV75</b>	
80 cm	<b>R90VADIV80</b>	
90 cm	<b>R90VADIV90</b>	

**PROFILO DI FINITURA RIGIDO  
IN ALLUMINIO**



Misure	Codice	Prezzo
1 lato 185 cm	<b>PRV185-30</b>	
2 lati 185x85 cm	<b>PRV18585-30</b>	
3 lati 85x185x85 cm	<b>PRV8518585-30</b>	

\*EVA è un materiale atossico, antibatterico e idrorepellente

## OPTIONAL PER VASCHE

### PROFILO DI FINITURA I. 400 cm



Codice	Prezzo
--------	--------

**PRVA2-A**

### PROFILO DI FINITURA IN PLASTICA



Codice	Prezzo
--------	--------

**PRVA195-30**

### TUBO DI SCARICO SALVAGOCCIA



Codice	Prezzo
--------	--------

**R90SCDOCBV**

IRIS, CALOS 2.0, UNA, VOGUE, VENUS, CALYPSO

### COLONNA DI SCARICO per vasche senza erogatore



Codice	Prezzo
--------	--------

**COLSCAVK-K**

### COLONNA DI SCARICO CON EROGATORE per vasche con erogatore



Codice	Prezzo
--------	--------

**COLSCAE-K**

### PANNELLO D'ISPEZIONE PER VASCA AD INCASSO 60x33x2 cm



SENSE

Codice	Prezzo
--------	--------

**PANISPEL-A**

IRIS, CALOS 2.0, UNA, VOGUE, VENUS, CALYPSO, BABY

Codice	Prezzo
--------	--------

**PANISP-A**

### KIT PIEDINI REGOLABILI PER VASCHE AD INCASSO per Sense, Iris, Calos 2.0



Codice	Prezzo
--------	--------

**PIEDVASCA**

### KIT PIEDINI REGOLABILI per Divina, Calos 2.0, Una, Vogue, Venus, Calypso



Codice	Prezzo
--------	--------

**PIEDVASCA70**

**PIEDVASCA75**

**PIEDVASCA80**

**PIEDVASCA90**

**PIEDVASCA100**

### KIT SOPRAVASCA DIVINA



Per il sopravasca Divina ordinare:

**1 sopravasca Young 2.0 1V/1BSV +  
1 kit raccordo vasca**

vedi pag. 580, 582

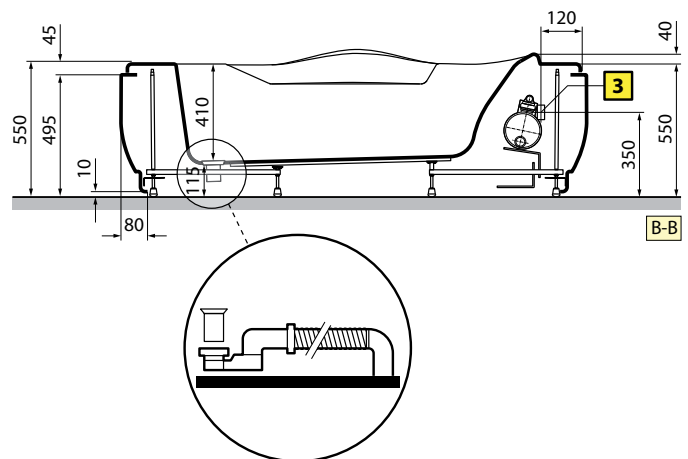
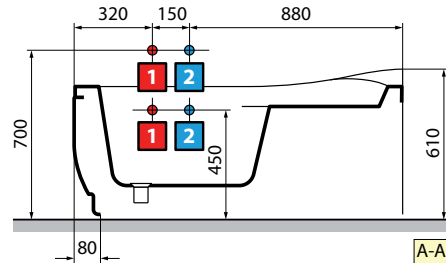
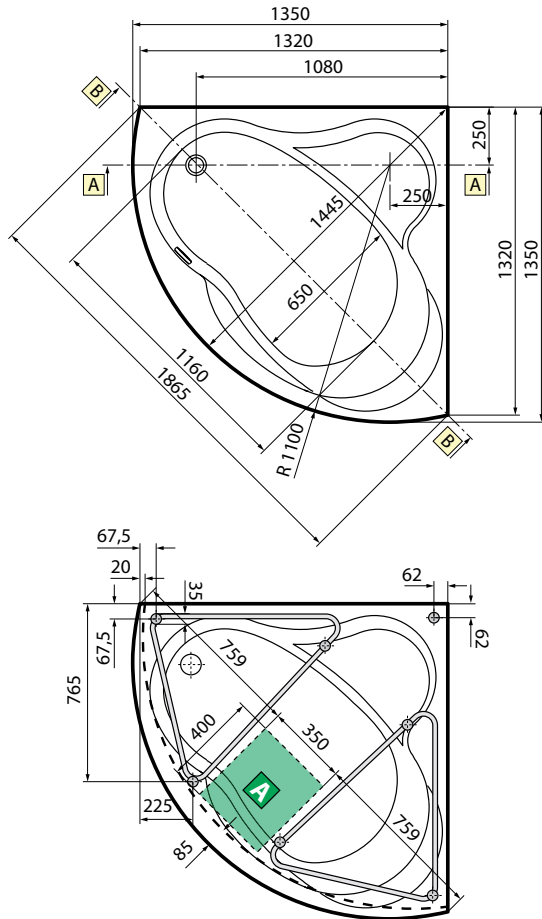

Capacità litri  
190

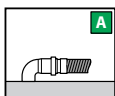

**ATTENZIONE!**  
Può essere dannoso ai portatori di pacemakers

Installare a monte dell'apparecchio un interruttore differenziale da 30mA provvisto di interruttore onnipolare con apertura minima dei contatti  $\geq 3$  mm.

**CARATTERISTICHE IDRAULICHE**

6 bocchette whirlpool  
12 bocchette airpool  
Allaccio sifone con raccordo 1 1/2"

**CARATTERISTICHE ELETTRICHE**

Tensione 220-230 V  
Frequenza 50 Hz  
Potenza massima assorbita: 950 W  
Whirlpool: 550 W  
Airpool: 400 W