



WHITE



TOTAL WHITE



BLACK



SILVER



CORDA

GLAX 2 2.0 | AUSSTATTUNG

	PROFILE	GRIFFE	PANEEL + ABLAGE	RÜCKWÄNDE	DUSCHWANNEN	DACH *	KLAPPSITZ *
WHITE	Schwarz Matt	Schwarz Matt	Weiß Matt	Schwarz	Weiß Matt	Weiß Matt	Weiß
TOTAL WHITE	Weiß Matt	Weiß Matt	Weiß Matt	Weiß	Weiß Matt	Weiß Matt	Weiß
BLACK	Weiß Matt	Weiß Matt	Schwarz Matt	Weiß	Schwarz Matt	Schwarz Matt	Weiß
SILVER	Silber	Chrom	Silber	Weiß	Weiß Glanz	Weiß Matt	Weiß
CORDA	Weiß Matt	Weiß Matt	Corda	Weiß	Corda	Corda	Weiß

* je nach Ausstattungsvariante

GLAX 2 2.0 | FUNKTIONEN UND AUSRÜSTUNG (je nach Version verfügbar)



- Thermostatmischer oder Mechanischer Armatur
- Kopfbrause
- Vertikale Wassermassagedüsen
- Ablage
- Bluetooth
- Klappbarer Sitz
- Elektronisches Bedienelement Soft-Touch
- Farblicht (Version Dampfdusche+Hydro Plus)
LED Beleuchtung (Version Hydro)
- Dampfbad+ Aromadisenser für Duftessenzen

GLAX 2 2.0 A+F



205 cm



6 mm Tür



5 mm



MULTIFUNKTIONSKABINE A+F ECKEINSTIEG MIT SCHIEBETÜREN + SEITENWAND

Design Marco Pellici



OPTIONAL



SITZ AUS ACRYL
SATINIERT

Code Preis

SED030PL

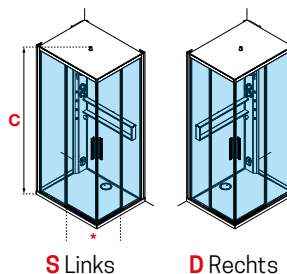

Maße				Code	Ausführung		Armatur		Glas	Farbe					
Maße (cm)	Brause-tasse (cm)	Höhe Kabine (cm)	Einstiegs-breite		D	S	M	T		1	UH	UU	HU	BB	TU
C				*		Rechts	Links	Mechanisch	Thermostat	ESG-Klar	White	Total white	Black	Silver	Corda

HYDRO

				D	S	M1-	T1-	1	UH	UU	HU	BB	TU
100 X 80	4,5	217	47,5	G22AF108									
100 X 80	11,5	224	47,5	G22AF198									

HYDRO PLUS

				D	S	M1L-	T1L-	1	UH	UU	HU	BB	TU
100 X 80	4,5	217	47,5	G22AF108									
100 X 80	11,5	224	47,5	G22AF198									

DAMPFBAD

				D	S	M5-	T5-	1	UH	UU	HU	BB	TU
100 X 80	4,5	217	47,5	G22AF108									
100 X 80	11,5	224	47,5	G22AF198									

SONDERAUSSTATTUNG

Flexibler Abflussschlauch		Code RISCCAB	Preis	Wasserenthärter für Dampfgenerator S.350		Code R90FLTATC01	Preis
---------------------------	--	------------------------	-------	--	--	----------------------------	-------

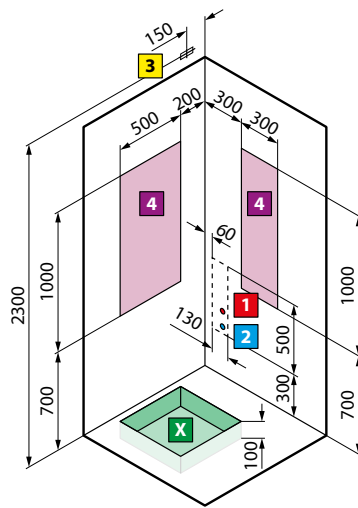
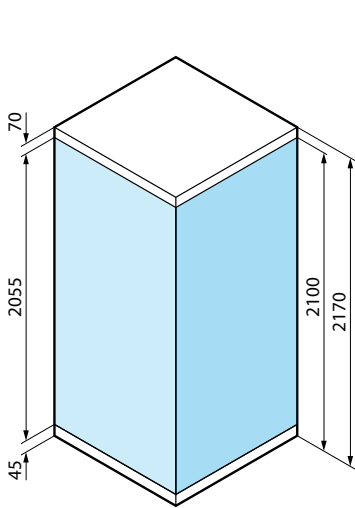

für Modelle
A80 - A90 - A100 - GF80 - GF90 - R90 - R100

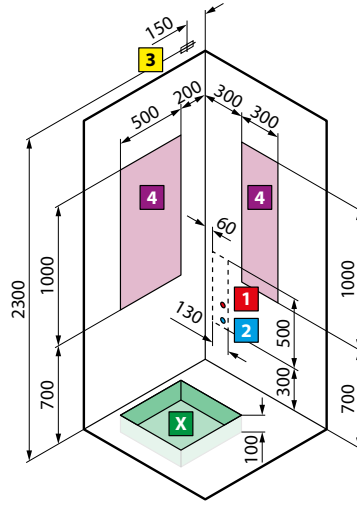

Version **Rechts**
für mod. **A90x70 - A100x70 - A100x80 - 2P 120x80 - 2P 120x90**

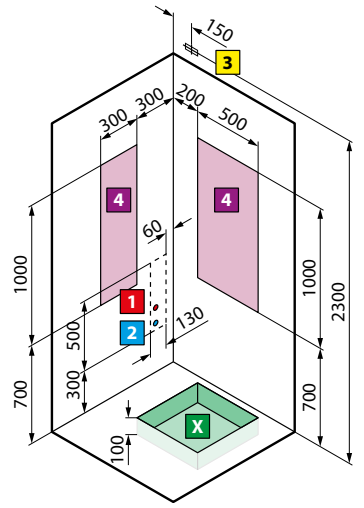

Version **Links**
für mod. **A90x70 - A100x70 - A100x80 - 2P 120x80 - 2P 120x90**

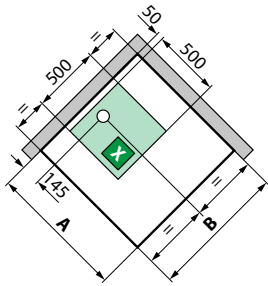

Modelle	A ± 3	B ± 3
A80	796	796
A90	896	896
A 100	996	996
GF80	796	796
GF90	896	896

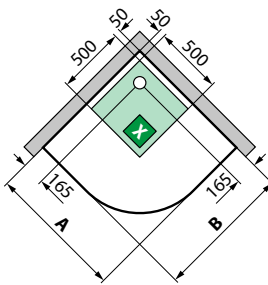

Modelle	A ± 3	B ± 3
R90	896	896
R100	996	996

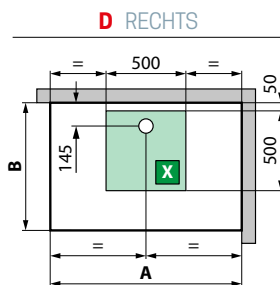
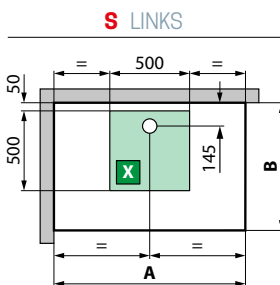

Modelle	A ± 3	B ± 3
A90x70	896	696
A100x70	996	696
A100x80	996	796
2P120x80	1196	796
2P120x90	1196	896

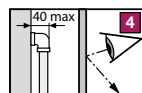
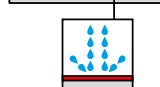
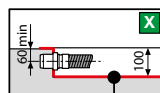
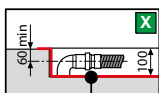

Brausetasse ohne Inspektionspaneel



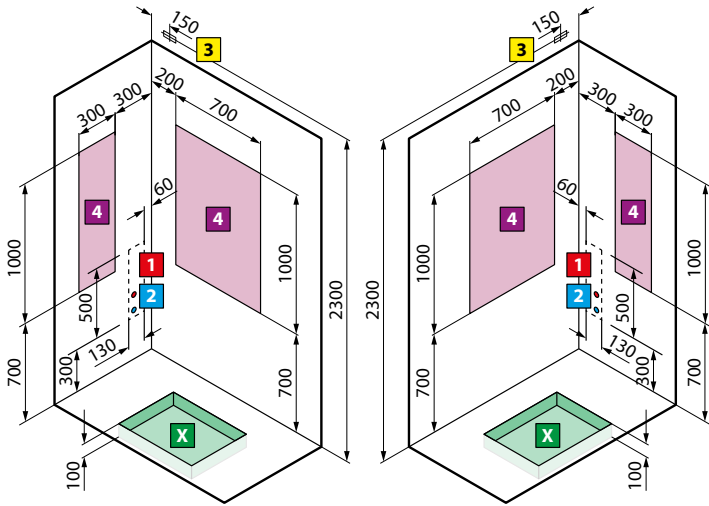

Version **Links**

Version **Rechts**

für mod. **2P140x80 - 2P140x90**

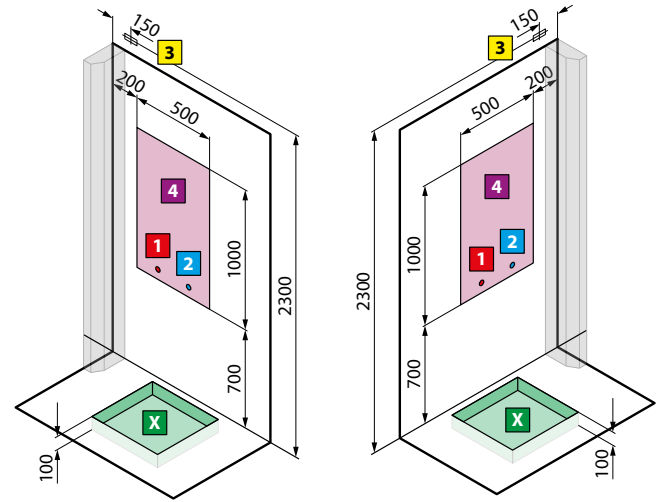

Version **Links**

Version **Rechts**

für mod. **A100x80**

für mod. **A100x80 - 2P120x80**

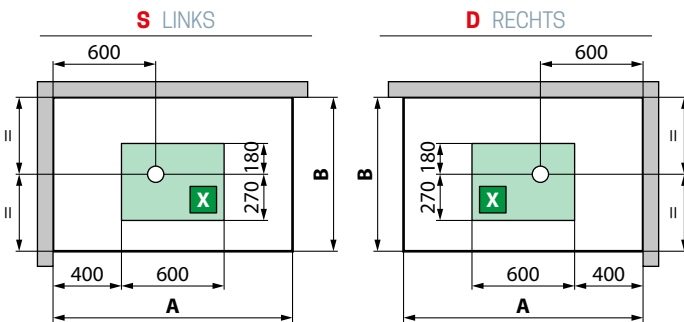

Modelle	A ± 3	B ± 3
2P140x80	1394	794
2P140x90	1394	894

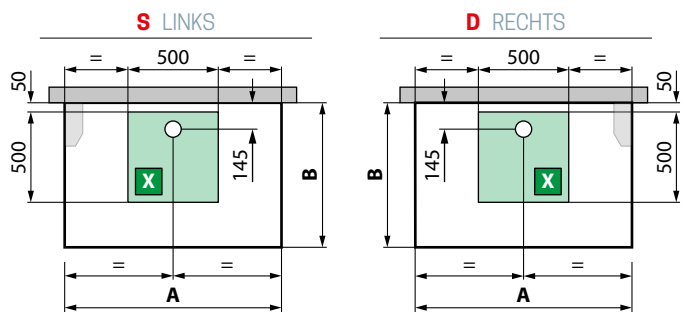

Modelle	A ± 3	B ± 3
A+F100x80	996	796
2P+2F120x80	1196	796

TECHNISCHE EIGENSCHAFTEN:
 Optimaler dynamischer Druck 2÷5 bar
 Warmwasseranschluss 1/2"
 Kaltwasseranschluss 1/2"
 Syphonanschluss ø 40 mm

ELEKTRISCHE ANSCHLUSSWERTE:
 Spannung 220 - 230 V
 Frequenz 50/60 Hz
 Max. Leistungsaufnahme: 2600 W
 Nennleistung: 2500 W

ACHTUNG! Vor der Installation der elektrischen Anlage muss ein 30mA Differentialschalter mit allpoliger Schaltereinheit eingebaut werden, mit einer Öffnung der Kontakte von mindestens 3 mm.

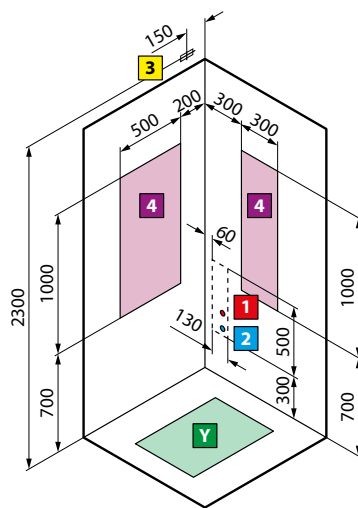
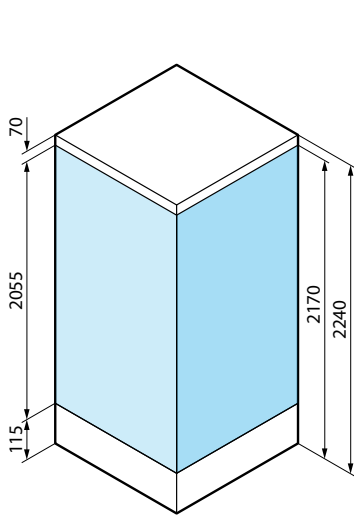

für Modelle
A80 - A90 - A100 - GF80 - GF90 - R90 - R100

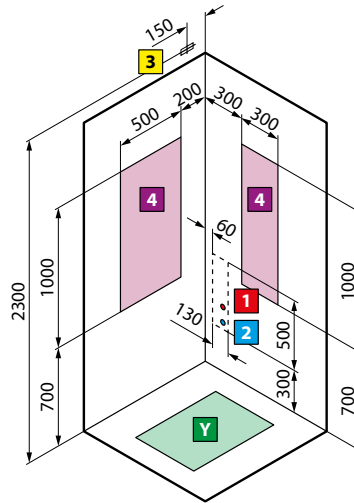

Version **Rechts** Version **Links**
für mod. **A90x70 - A100x70 - A100x80 - 2P120x80 - 2P120x90**

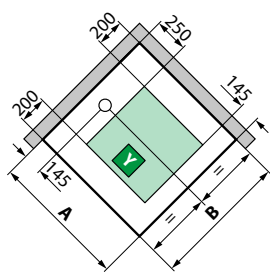
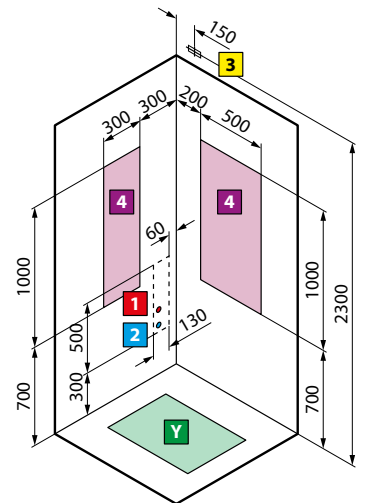

Modelle	A ± 3	B ± 3
A80	796	796
A90	896	896
A 100	996	996
GF80	796	796
GF90	896	896

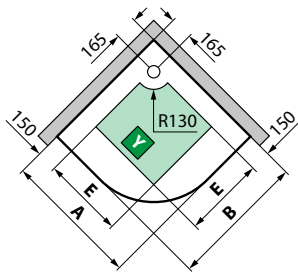

Modelle	A ± 3	B ± 3
R90	896	896
R100	996	996

S LINKS

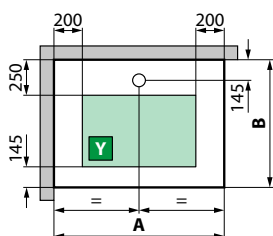

D RECHTS

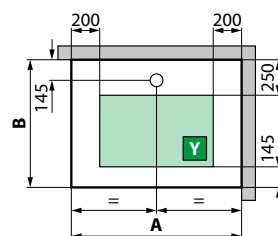

Modelle	A ± 3	B ± 3
A90x70	896	696
A100x70	996	696
A100x80	996	796
2P120x80	1196	796
2P120x90	1196	896

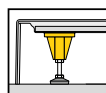
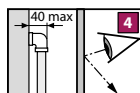
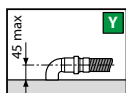

ACHTUNG!
Kann für Personen mit Herzschrittmacher gefährlich sein.

Brausetasse ohne Inspektionspaneel

GLAX 2.0 DUSCHWANNEN 125 MM TECHNISCHE SKIZZEN

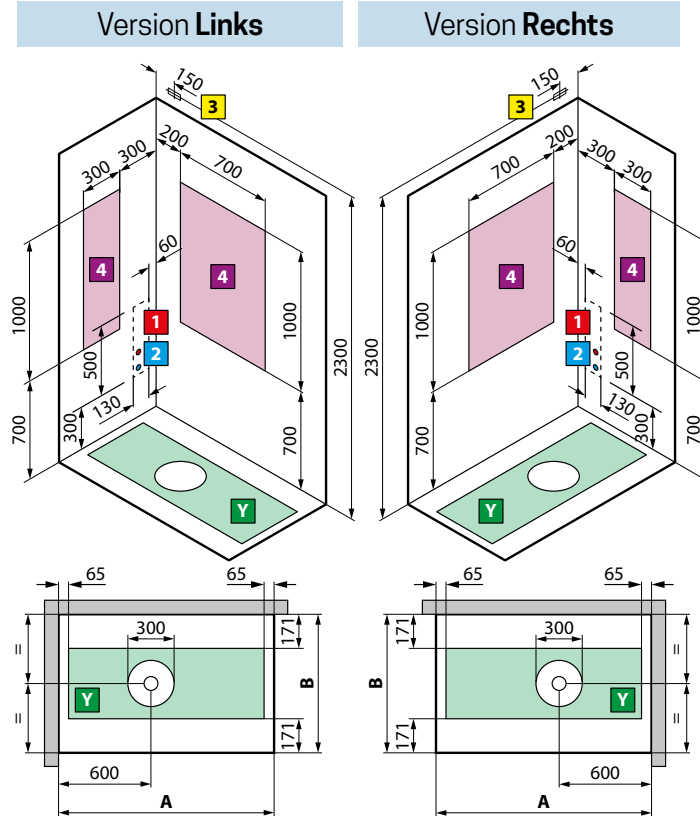
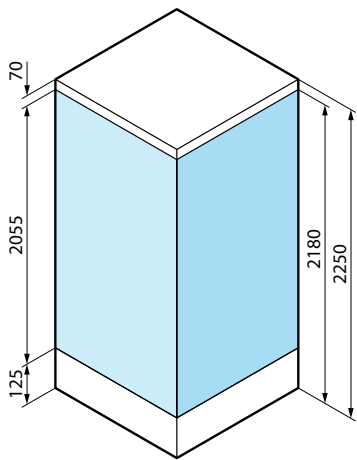

Modelle	A ± 3	B ± 3
2P140x80	1398	798
2P140x90	1398	898

GLAX 2.0 DUSCHWANNEN 115 MM

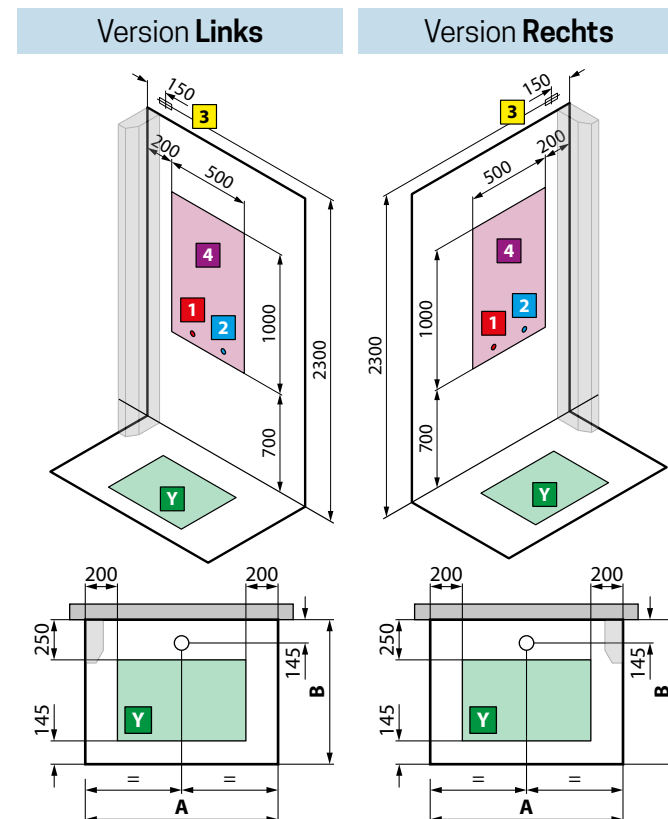
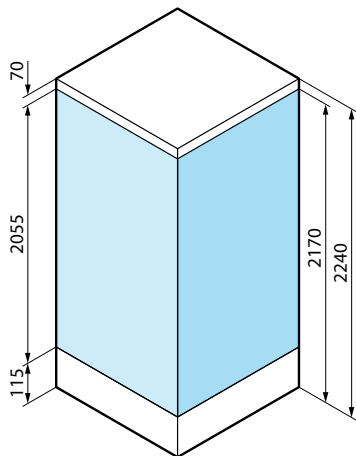

Modelle	A ± 4	B ± 4
A+F100x80	998	798
2P+2F120x80	1198	798

TECHNISCHE EIGENSCHAFTEN:
 Optimaler dynamischer Druck 2-5 bar
 Warmwasseranschluss 1/2"
 Kaltwasseranschluss 1/2"
 Syphonanschluss ø 40 mm

ELEKTRISCHE ANSCHLUSSWERTE:
 Spannung 220 - 230 V
 Frequenz 50/60 Hz
 Max. Leistungsaufnahme: 2600 W
 Nennleistung: 2500 W

ACHTUNG! Vor der Installation der elektrischen Anlage muss ein 30mA Differentialschalter mit allpoliger Schaltereinheit eingebaut werden, mit einer Öffnung der Kontakte von mindestens 3 mm.