

# GLAX 22.0 A

**CORNER ENTRY, 2 SLIDING DOORS + 2 FIXED PANELS**

Design Marco Pellici



Misure				Codice	Installation		Mixer		Glass	Scelta finitura				
Dimensions (cm)	Shower tray (cm)	Total height (cm)	Access		D	S	M	T	1	UH	UU	HU	BB	TU
		<b>C</b>	*		Right	Left	Manual	Thermostatic	Clear	White	Total White	Black	Silver	Corda

HYDRO														
					D	S	M1-	T1-	1	UH	UU	HU	BB	TU
80 X 80	4,5	217	40	<b>G22A80</b>										
80 X 80	11,5	224	40	<b>G22A89</b>										
90 X 90	4,5	217	47	<b>G22A90</b>										
90 X 90	11,5	224	47	<b>G22A99</b>										
100 X 100	4,5	217	54	<b>G22A100</b>										
100 X 100	11,5	224	54	<b>G22A109</b>										
90 X 70	4,5	217	40	<b>G22A9070</b>										
90 X 70	11,5	224	40	<b>G22A9079</b>										
100 X 70	4,5	217	43,5	<b>G22A107</b>										
100 X 70	11,5	224	43,5	<b>G22A197</b>										
100 X 80	4,5	217	47,5	<b>G22A108</b>										
100 X 80	11,5	224	47,5	<b>G22A198</b>										

HYDRO PLUS														
					D	S	M1L-	T1L-	1	UH	UU	HU	BB	TU
80 X 80	4,5	217	40	<b>G22A80</b>										
80 X 80	11,5	224	40	<b>G22A89</b>										
90 X 90	4,5	217	47	<b>G22A90</b>										
90 X 90	11,5	224	47	<b>G22A99</b>										
100 X 100	4,5	217	54	<b>G22A100</b>										
100 X 100	11,5	224	54	<b>G22A109</b>										
90 X 70	4,5	217	40	<b>G22A9070</b>										
90 X 70	11,5	224	40	<b>G22A9079</b>										
100 X 70	4,5	217	43,5	<b>G22A107</b>										
100 X 70	11,5	224	43,5	<b>G22A197</b>										
100 X 80	4,5	217	47,5	<b>G22A108</b>										
100 X 80	11,5	224	47,5	<b>G22A198</b>										

HAMMAM														
					D	S	M5-	T5-	1	UH	UU	HU	BB	TU
80 X 80	4,5	217	40	<b>G22A80</b>										
80 X 80	11,5	224	40	<b>G22A89</b>										
90 X 90	4,5	217	47	<b>G22A90</b>										
90 X 90	11,5	224	47	<b>G22A99</b>										
100 X 100	4,5	217	54	<b>G22A100</b>										
100 X 100	11,5	224	54	<b>G22A109</b>										
90 X 70	4,5	217	40	<b>G22A9070</b>										
90 X 70	11,5	224	40	<b>G22A9079</b>										
100 X 70	4,5	217	43,5	<b>G22A107</b>										
100 X 70	11,5	224	43,5	<b>G22A197</b>										
100 X 80	4,5	217	47,5	<b>G22A108</b>										
100 X 80	11,5	224	47,5	<b>G22A198</b>										



GLAX 2.2.0

**GLAX 2.2.0 A TOTAL WHITE**

80x80 | 90x90 | 100x100

90x70 | 100x70 | 100x80

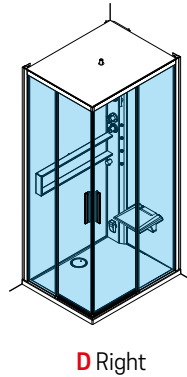
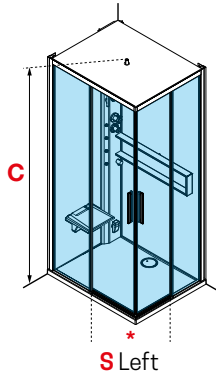
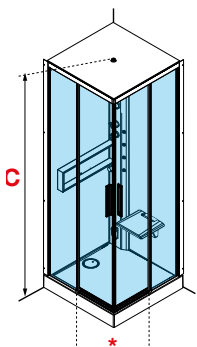

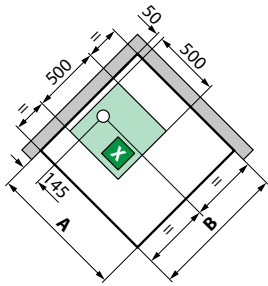
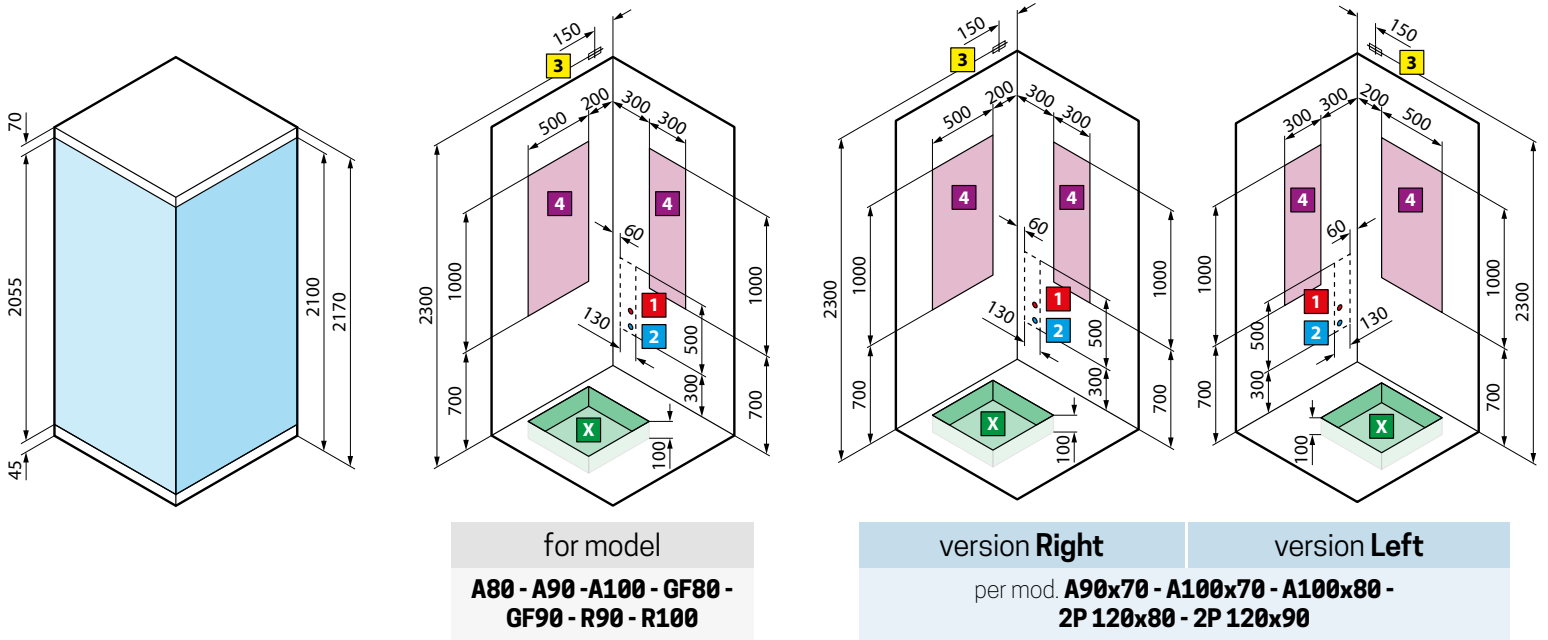

model	A ± 3	B ± 3
<b>A80</b>	796	796
<b>A90</b>	896	896
<b>A 100</b>	996	996
<b>GF80</b>	796	796
<b>GF90</b>	896	896

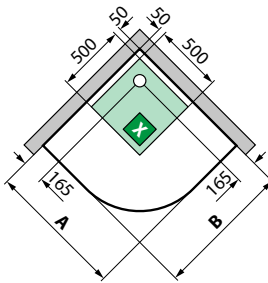

model	A ± 3	B ± 3
<b>R90</b>	896	896
<b>R100</b>	996	996

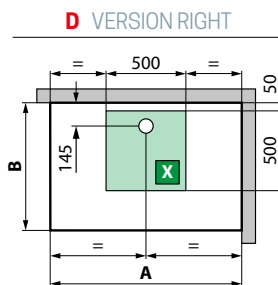
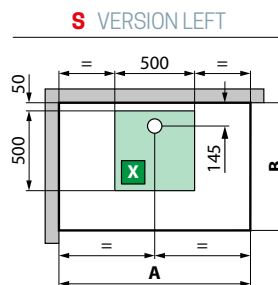

model	A ± 3	B ± 3
<b>A90x70</b>	896	696
<b>A100x70</b>	996	696
<b>A100x80</b>	996	796
<b>2P120x80</b>	1196	796
<b>2P120x90</b>	1196	896

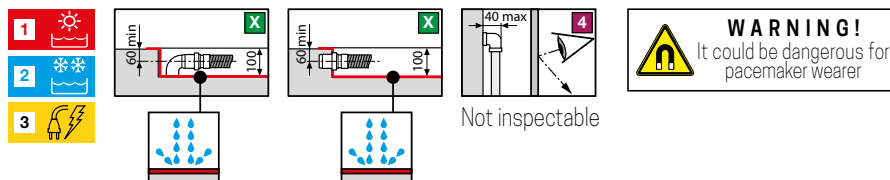

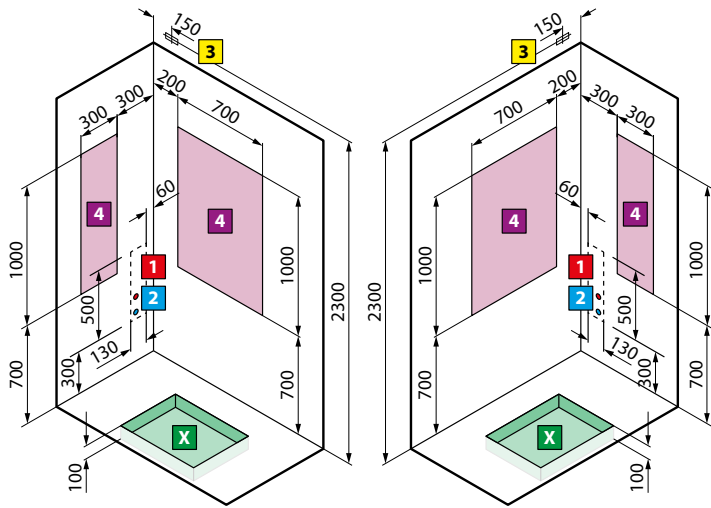

version **Left**

version **Right**

per mod. **2P140x80 - 2P140x90**

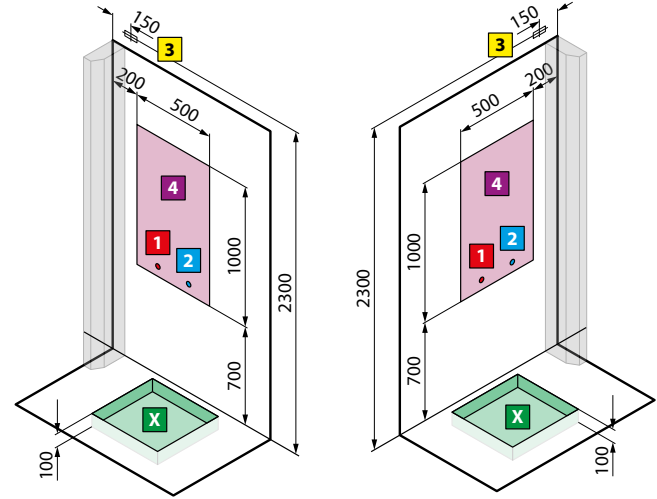

version **Left**

version **Right**

per mod. **A100x80**

per mod. **A100x80 - 2P120x80**

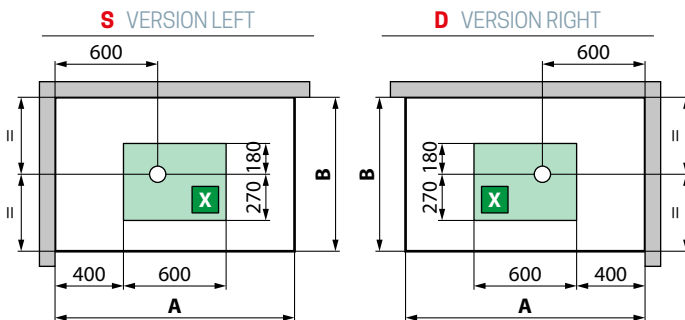

model	A ± 3	B ± 3
<b>2P140x80</b>	1394	794
<b>2P140x90</b>	1394	894

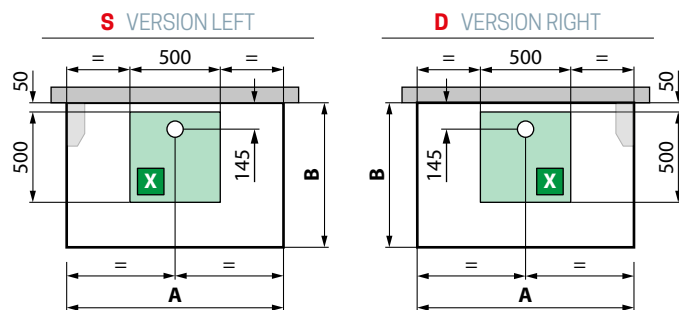

model	A ± 3	B ± 3
<b>A+F100x80</b>	996	796
<b>2P+2F120x80</b>	1196	796

**HYDRAULIC CHARACTERISTICS:**  
 Optimal dynamic pressure 2÷5 bar  
 Hot water 1/2"  
 Cold water 1/2"  
 Drain connection ø 40 mm

**ELECTRICAL CHARACTERISTIC:**  
 Supply voltage: 220-230 V  
 Frequency: 50/60 Hz  
 Maximum absorbed power: 2600 W  
 Nominal power rating: 2500 W

**WARNING!** Install a 30mA differential switch upstream of the appliance with a multiple-pole switch with a minimum contact opening ≥ 3 mm.

# GLAX 2.0 SHOWER TRAY 125

# TECHNICAL DATA

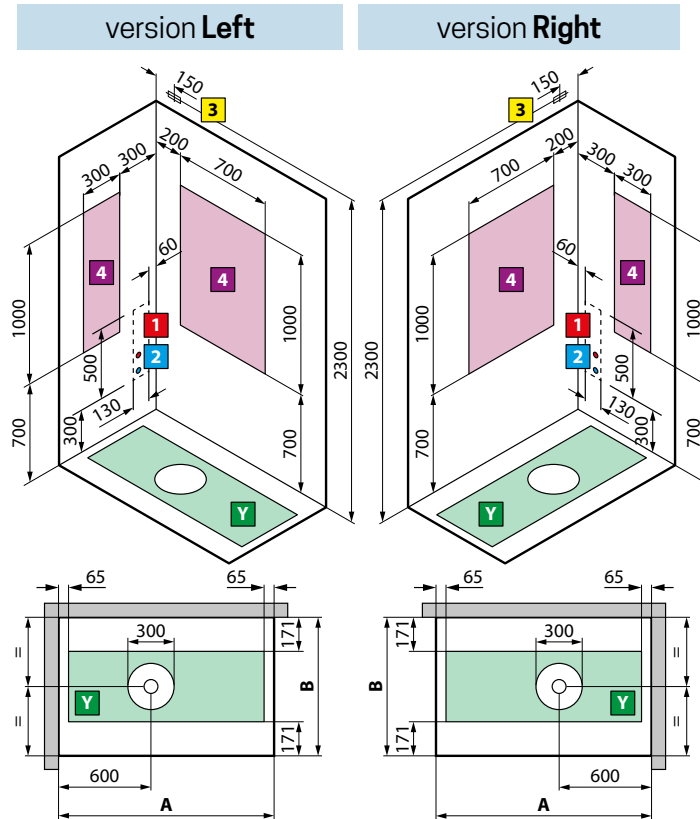
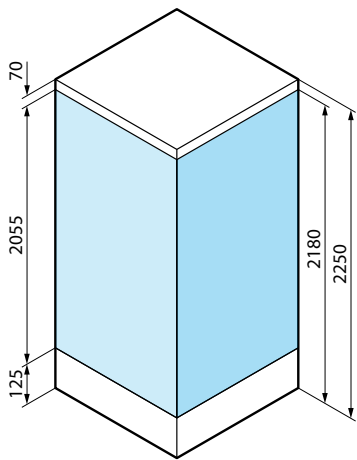

model	A ± 3	B ± 3
<b>2P140x80</b>	1398	798
<b>2P140x90</b>	1398	898

# GLAX 2.0 SHOWER TRAY 115

# DISEGNI TECNICI

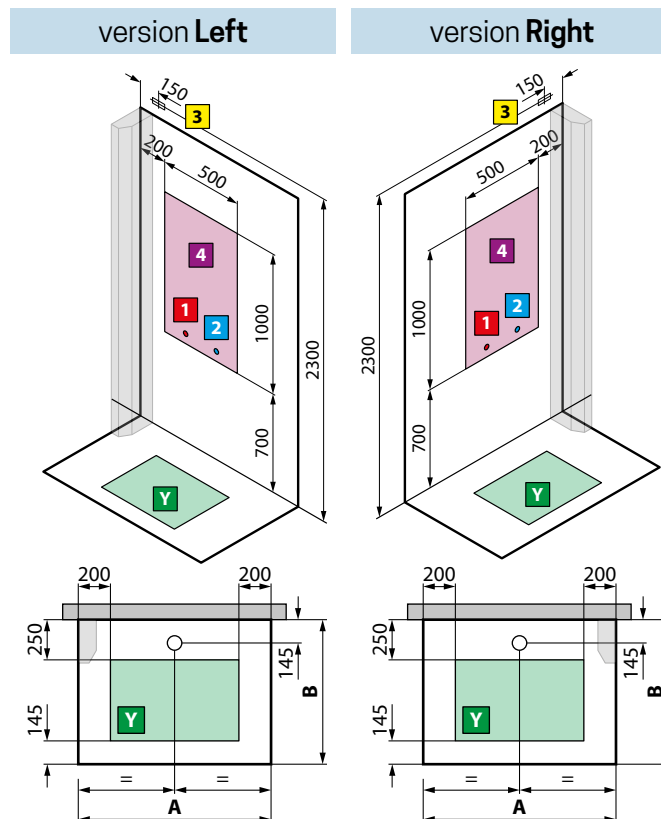
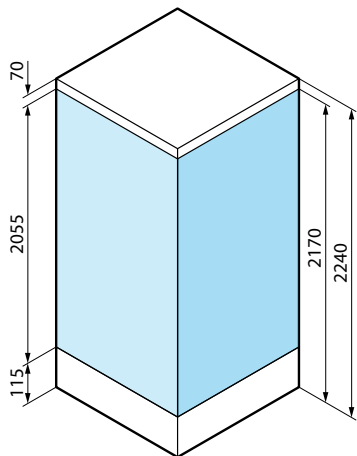

model	A ± 4	B ± 4
<b>A+F100x80</b>	998	798
<b>2P+2F120x80</b>	1198	798

**HYDRAULIC CHARACTERISTICS:**  
 Optimal dynamic pressure 2-5 bar  
 Hot water 1/2"  
 Cold water 1/2"  
 Drain connection ø 40 mm

**ELECTRICAL CHARACTERISTIC:**  
 Supply voltage: 220-230 V  
 Frequency: 50/60 Hz  
 Maximum absorbed power: 2600 W  
 Nominal power rating: 2500 W

**WARNING!** Install a 30mA differential switch upstream of the appliance with a multiple-pole switch with a minimum contact opening ≥ 3 mm.

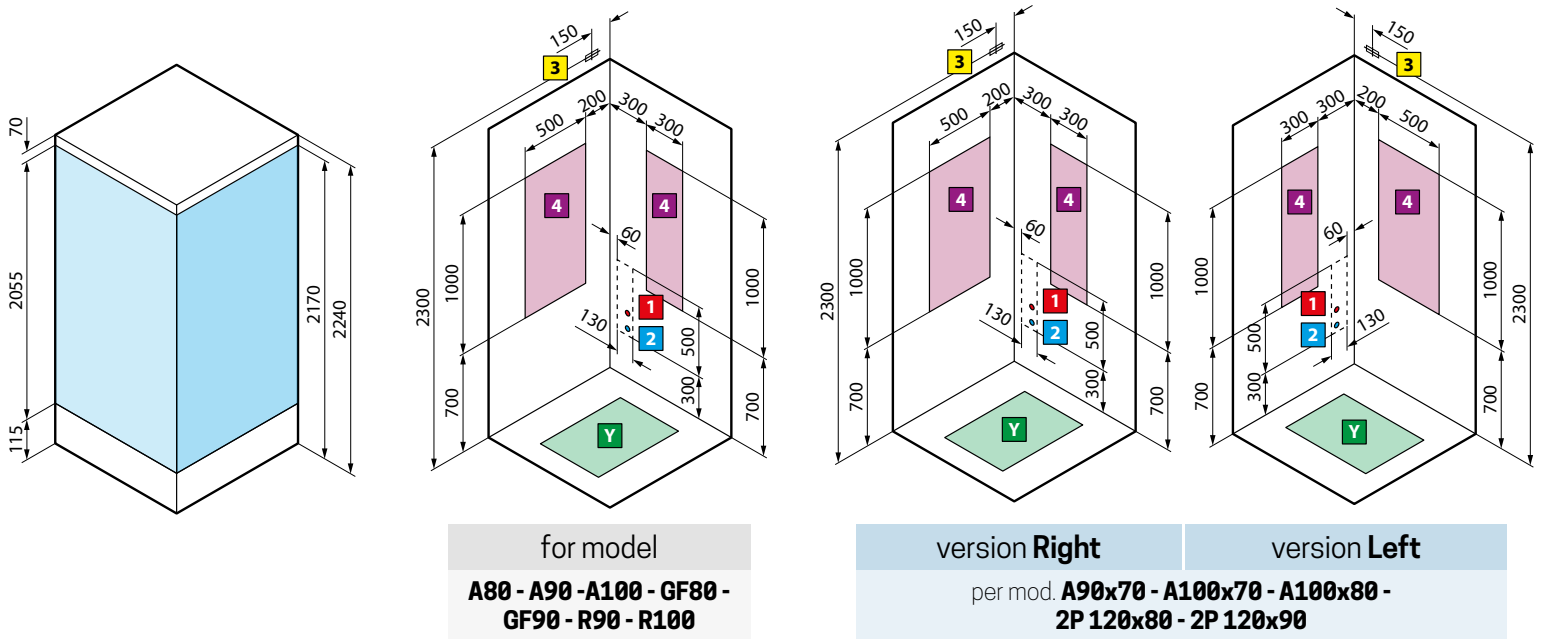

for model  
**A80 - A90 - A100 - GF80 - GF90 - R90 - R100**

version **Right**      version **Left**  
per mod. **A90x70 - A100x70 - A100x80 - 2P120x80 - 2P120x90**

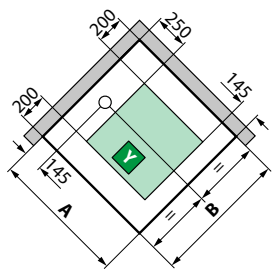

model	A ± 4	B ± 4
<b>A80</b>	798	798
<b>A90</b>	898	898
<b>A100</b>	998	998
<b>GF80</b>	798	798
<b>GF90</b>	898	898

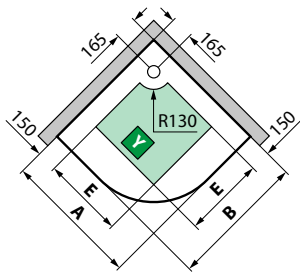

model	A ± 4	B ± 4	E
<b>R90</b>	898	898	500
<b>R100</b>	998	998	600

**S** VERSION LEFT

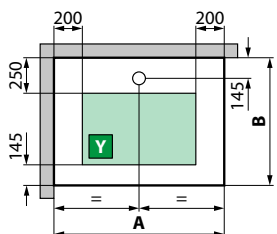

**D** VERSION RIGHT

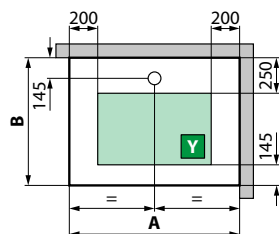

model	A ± 4	B ± 4
<b>A90x70</b>	898	698
<b>A100x70</b>	998	698
<b>A100x80</b>	998	798
<b>2P120x80</b>	1198	798
<b>2P120x90</b>	1198	898

1

2

3

Y

4

5

6

Not inspectable

