

CARACTERÍSTICAS

Funções Gerais	16 jatos de ar na base	6 jatos laterais de hidromassagem	Misturador monocomando e ducha manual	Ralo retangular click-clack	Travesseiro	Chromolight	Painel de controle soft-touch	Bluetooth
								
HYDRO PLUS	●	●	●	●	●	●	●	●

OPCIONAL



R90PODIV

Suporte porta objetos

ACABAMENTO

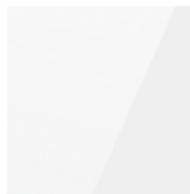

Acrílico Branco
Brilhante

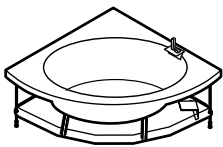

Modelos	Dimensões cm	Capacidade
DIVB4140140O2-AOK	140 x 140	400 lt

Versões

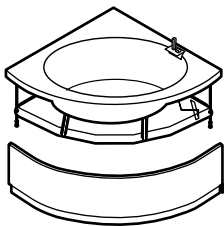

Painel de Fechamento

PANVFDIVC-A

DIVINA C HYDRO PLUS

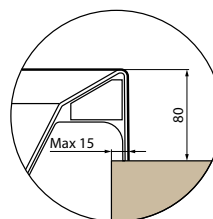
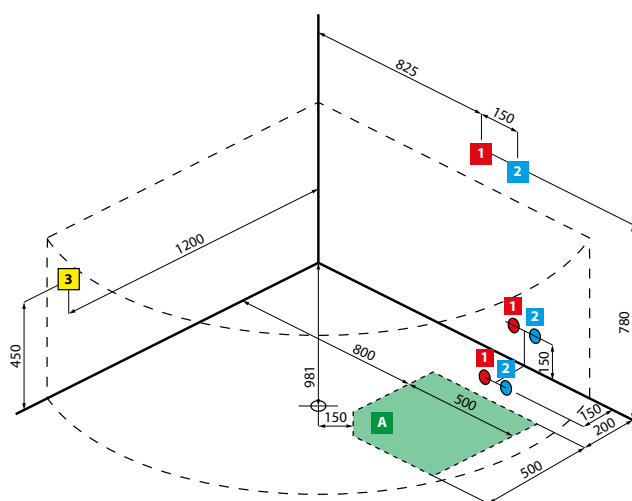
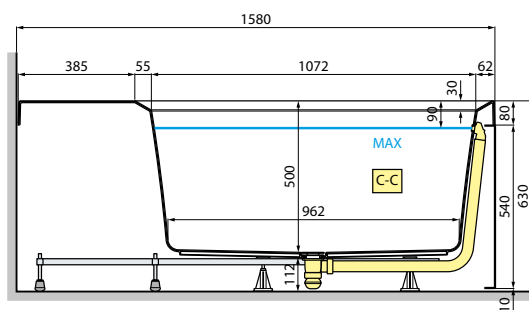
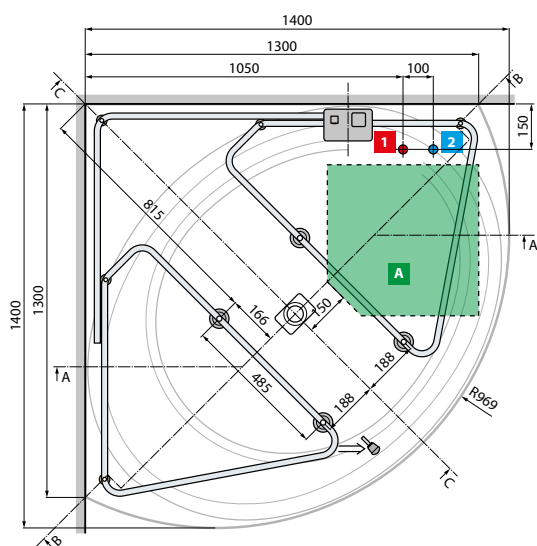
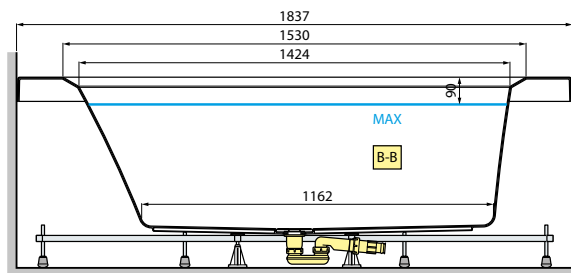
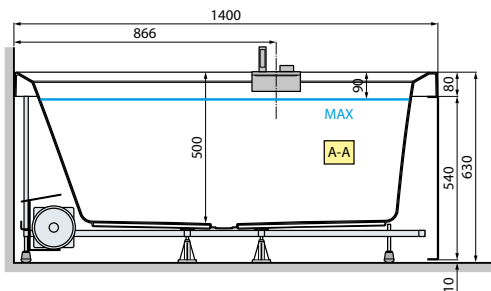

Capacidade

400 lt



3a Instalação elétrica no caso da banheira ser instalada de canto

3b Instalação elétrica no caso da banheira ser instalada na parede reta

3c Instalação elétrica no caso da banheira na versão ilha

CARACTERÍSTICAS HIDRÁULICAS

- 16 Jatos airpool
- Sifão de conexão 1 1/2"
- 6 jatos de hidromassagem

CARACTERÍSTICAS ELÉTRICAS

- Voltagem 220-230 V
- Frequência 60 Hz
- Máxima potência absorvida:
Whirlpool: 900 W
Airpool: 400 W
Plus: 1300 W

Antes da instalação elétrica da banheira, deve-se instalar um diferencial de 30 mA provisto de interruptor com ≥ 3 mm de abertura mínima dos contatos.