











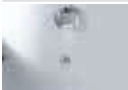













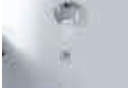









UNA

ECKWANNE

Badewanne	Mass		Code	Wahl der Armaturen			Wahl der Anzahl der Schürzen /Preis				
	cm	H		Ab- und Überlaufgarnitur	Aufpreis für Wanneneinlauf	Ablaugarnitur mit Wannerrand armatur	Mit Gestell	1 Schürze			
STANDARD											
EINBAUMODELL	135 x 135	55	UNA1135135-A	◇	◇	◇					
				C-	E-	F-	A0	A1			
											
											
MIT GESTELL	135 x 135	55	UNA2135135								
HYDRO											
				C-	E-	F-	A0K	A1K			
											
											
HYDROMASSAGE	135 x 135	55	UNA5135135O								
											
											
HYDROMASSAGE + DESINFektionsANLAGE	135 x 135	55	UNA3135135P								
HYDRO PLUS											
				C-	E-	F-	A0K	A1K			
											
											
PLUS VERSION	135 x 135	55	UNA4135135P								

Zusammensetzung der Bestellnummer: Code + Armatur + Schürzen = Artikelnummer



HYDRO PLUS

EIN KLASSIKER - HYDROMASSAGE MIT WASSER- UND LUFTSTRAHLUNG



Touch Screen Fernbedienung

Desinfektionsanlage



Wannenrandarmatur mit Kaskadeneinlauf

12 Airpool Düsen



Ab- und Überlaufgarnitur

6 Whirlpooldüsen

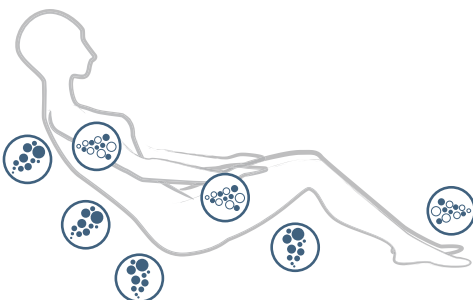



















Airpool- Massage mit manueller oder sequenzieller Einstellung für eine effektive Stimulation der Körperzellen.



Whirlpool- Massage mit Ein- Ausschaltung des Whirlpoolsystems, elektr. Intensitätskontrolle und modulierender Intensität.

SONDERAUSSTATTUNG FÜR BADEWANNEN

 <p>NACKENSTÜTZE (EVA *) für Calos</p> <table border="1"> <tr> <td>Code</td> <td></td> </tr> <tr> <td>POGCA1</td> <td></td> </tr> </table>	Code		POGCA1		 <p>NACKENSTÜTZE (EVA *) für Vogue</p> <table border="1"> <tr> <td>Code</td> <td></td> </tr> <tr> <td>POGVOG</td> <td></td> </tr> </table>	Code		POGVOG												
Code																				
POGCA1																				
Code																				
POGVOG																				
 <p>NACKENSTÜTZE (EVA *) für Calypso</p> <table border="1"> <tr> <td>Code</td> <td></td> </tr> <tr> <td>POGCAL</td> <td></td> </tr> </table>	Code		POGCAL		 <p>NACKENSTÜTZE VERKÜRZT (EVA *) für Iris Nischeneinbau</p> <table border="1"> <tr> <td>Code</td> <td></td> </tr> <tr> <td>POGIRIN</td> <td></td> </tr> </table>	Code		POGIRIN												
Code																				
POGCAL																				
Code																				
POGIRIN																				
 <p>NACKENSTÜTZE (EVA *) für Divina und Divina O</p> <table border="1"> <tr> <td>Code</td> <td></td> </tr> <tr> <td>POGDIV</td> <td></td> </tr> </table>	Code		POGDIV		 <p>NACKENSTÜTZE (EVA *) für Divina C</p> <table border="1"> <tr> <td>Code</td> <td></td> </tr> <tr> <td>POGDIVC</td> <td></td> </tr> </table>	Code		POGDIVC												
Code																				
POGDIV																				
Code																				
POGDIVC																				
 <p>ABLAGE WANNENRAND für Divina, Divina C, O und F</p> <table border="1"> <tr> <td>Code</td> <td></td> </tr> <tr> <td>R90PODIV</td> <td></td> </tr> </table>	Code		R90PODIV		 <p>ABLAGE für Divina und Divina F</p> <table border="1"> <thead> <tr> <th>Länge</th> <th>Code</th> <th></th> </tr> </thead> <tbody> <tr> <td>70 cm</td> <td>R90VADIV70</td> <td></td> </tr> <tr> <td>75 cm</td> <td>R90VADIV75</td> <td></td> </tr> <tr> <td>80 cm</td> <td>R90VADIV80</td> <td></td> </tr> <tr> <td>90 cm</td> <td>R90VADIV90</td> <td></td> </tr> </tbody> </table>	Länge	Code		70 cm	R90VADIV70		75 cm	R90VADIV75		80 cm	R90VADIV80		90 cm	R90VADIV90	
Code																				
R90PODIV																				
Länge	Code																			
70 cm	R90VADIV70																			
75 cm	R90VADIV75																			
80 cm	R90VADIV80																			
90 cm	R90VADIV90																			
 <p>WANNENRANDPROFILE</p> <table border="1"> <tr> <td>Code</td> <td></td> </tr> <tr> <td>PRVA2-A</td> <td></td> </tr> </table>	Code		PRVA2-A		 <p>WANNENFÜSSE FÜR EINBAUWANNE für Sense, Divina, Iris, Calos,</p> <table border="1"> <tr> <td>Code</td> <td></td> </tr> <tr> <td>PIEDVASCA70</td> <td></td> </tr> <tr> <td>PIEDVASCA75</td> <td></td> </tr> <tr> <td>PIEDVASCA80</td> <td></td> </tr> <tr> <td>PIEDVASCA90</td> <td></td> </tr> <tr> <td>PIEDVASCA100</td> <td></td> </tr> </table>	Code		PIEDVASCA70		PIEDVASCA75		PIEDVASCA80		PIEDVASCA90		PIEDVASCA100				
Code																				
PRVA2-A																				
Code																				
PIEDVASCA70																				
PIEDVASCA75																				
PIEDVASCA80																				
PIEDVASCA90																				
PIEDVASCA100																				
 <p>WANNENRANDPROFILE</p> <table border="1"> <thead> <tr> <th>Mass</th> <th>Code</th> <th></th> </tr> </thead> <tbody> <tr> <td>1 Länge 185 cm</td> <td>PRV185-30</td> <td></td> </tr> <tr> <td>2 Längen 185x85 cm</td> <td>PRV18585-30</td> <td></td> </tr> <tr> <td>3 Längen 85x185x85 cm</td> <td>PRV8518585-30</td> <td></td> </tr> </tbody> </table>	Mass	Code		1 Länge 185 cm	PRV185-30		2 Längen 185x85 cm	PRV18585-30		3 Längen 85x185x85 cm	PRV8518585-30		 <p>KIT 2 PLASTIKPROFILE 195 CM LANG</p> <table border="1"> <tr> <td>Code</td> <td></td> </tr> <tr> <td>PRVA195-30</td> <td></td> </tr> </table>	Code		PRVA195-30				
Mass	Code																			
1 Länge 185 cm	PRV185-30																			
2 Längen 185x85 cm	PRV18585-30																			
3 Längen 85x185x85 cm	PRV8518585-30																			
Code																				
PRVA195-30																				
 <p>KIT 2 PLASTIKPROFILE 195 CM LANG</p> <table border="1"> <tr> <td>Code</td> <td></td> </tr> <tr> <td>PRVA195-30</td> <td></td> </tr> </table>	Code		PRVA195-30		 <p>KIT EINSTELLBARE FÜSSE für Calos, Una, Vogue, Calypso</p> <table border="1"> <tr> <td>Code</td> <td></td> </tr> <tr> <td>PIEDVASCA</td> <td></td> </tr> </table>	Code		PIEDVASCA												
Code																				
PRVA195-30																				
Code																				
PIEDVASCA																				
 <p>HANDBRAUSESCHLAUCH MIT TROPFEN-SCHUTZVORRICHTUNG</p> <table border="1"> <tr> <td>Code</td> <td></td> </tr> <tr> <td>R90SCDOCBV</td> <td></td> </tr> </table>	Code		R90SCDOCBV		 <p>AUFPREIS FÜR WANNENEINLAUF für Badewannen mit Einlauf</p> <table border="1"> <tr> <td>Code</td> <td></td> </tr> <tr> <td>COLSCAE-K</td> <td></td> </tr> </table>	Code		COLSCAE-K												
Code																				
R90SCDOCBV																				
Code																				
COLSCAE-K																				
 <p>AB- UND ÜBERLAUFGARNITUR für Versionen ohne Wanneneinlauf</p> <table border="1"> <tr> <td>Code</td> <td></td> </tr> <tr> <td>COLSCAVK-K</td> <td></td> </tr> </table>	Code		COLSCAVK-K		 <p>WARTUNGS- UND INSPEKTIONSDECKEL</p> <table border="1"> <thead> <tr> <th colspan="2">Sense</th> <th colspan="2">Iris, Calos, Una, Vogue, Calypso, Baby</th> </tr> <tr> <th>Code</th> <th></th> <th>Code</th> <th></th> </tr> </thead> <tbody> <tr> <td>PANISPEL-A</td> <td></td> <td>PANISP-A</td> <td></td> </tr> </tbody> </table>	Sense		Iris, Calos, Una, Vogue, Calypso, Baby		Code		Code		PANISPEL-A		PANISP-A				
Code																				
COLSCAVK-K																				
Sense		Iris, Calos, Una, Vogue, Calypso, Baby																		
Code		Code																		
PANISPEL-A		PANISP-A																		

* EVA ist ein antitoxisches Material, antibakteriell und bakterizid mit langer Lebensdauer. EVA ist ein weicher, isolierender, reiss- und rutschfester Schaumstoff, welcher kein Wasser aufnimmt.

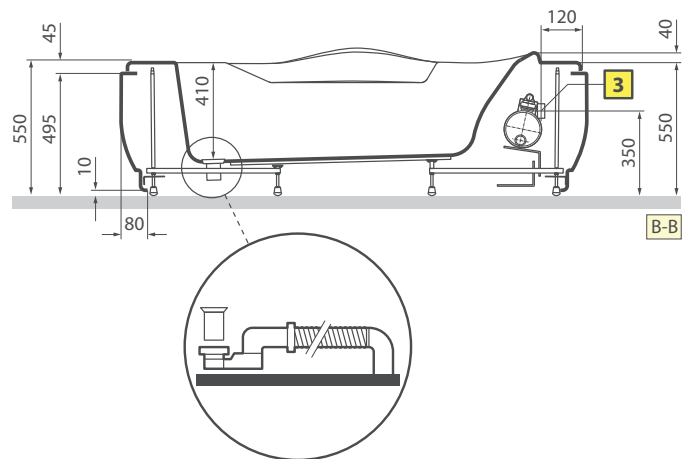
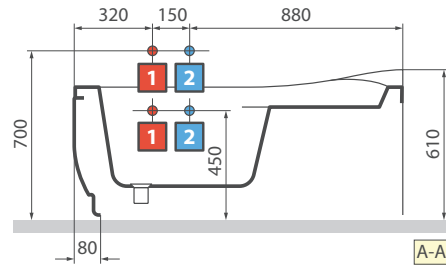
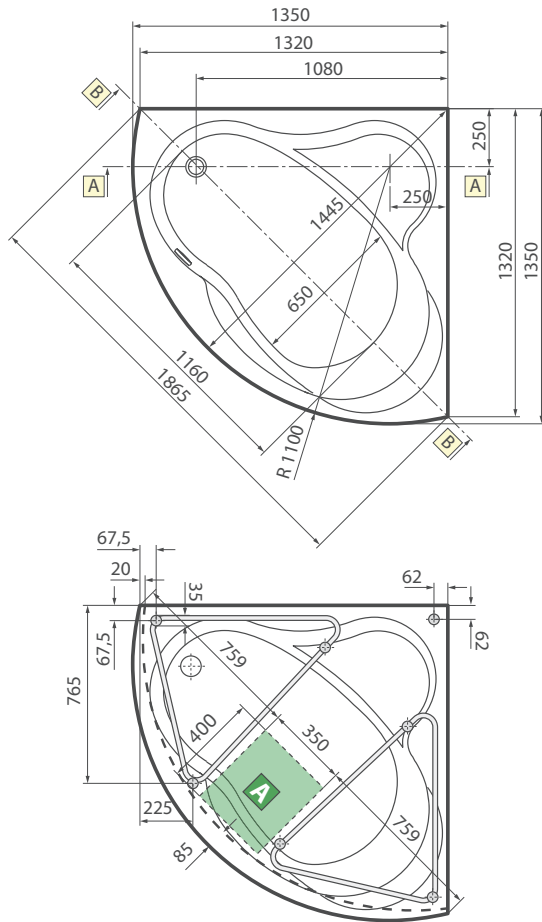

Kapazität lt
190

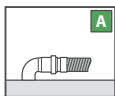

ACHTUNG!
Kann für Personen mit Herzschrittmacher gefährlich sein.

Vor der elektrischen Anlage der Badewanne muss ein 30mA Differentialschalter mit allpoliger Schaltereinheit eingebaut werden, mit einer Mindestöffnung der Kontakte von mindestens 3 mm.

TECHNISCHE EIGENSCHAFTEN

- 6 Whirldüsen
- 12 Airdüsen
- Abflussanschluss 1 1/2"

ELEKTRISCHE ANSCHLUSSWERTE

- Spannung 220-230 V
- Frequenz 50 Hz
- Gesamt-Anschlusswerte: 950 W
- Whirlpool: 550 W
- Airpool: 400 W